

RF Transistor

8 V, 150 mA, $f_T = 16$ GHz
NPN Single MCP4

MCH4020

Features

- Low-Noise use: $NF = 1.2$ dB typ ($f = 1$ GHz)
- High Cut-off Frequency: $f_T = 16$ GHz typ ($V_{CE} = 5$ V)
- High Gain: $|S_{21e}|^2 = 17.5$ dB typ ($f = 1$ GHz)
- Small ON-resistance (R_{on})
- This Device is Pb-Free, Halogen Free and are RoHS Compliant

Specifications

ABSOLUTE MAXIMUM RATINGS ($T_A = 25^\circ\text{C}$)

| Symbol | Parameter | Conditions | Ratings | Unit |
|-----------|------------------------------|------------|-------------|------------------|
| V_{CBO} | Collector-to-Base Voltage | | 15 | V |
| V_{CEO} | Collector-to-Emitter Voltage | | 8 | V |
| V_{EBO} | Emitter-to-Base Voltage | | 2 | V |
| I_C | Collector Current | | 150 | mA |
| P_C | Collector Dissipation | | 400 | mW |
| T_j | Junction Temperature | | 150 | $^\circ\text{C}$ |
| T_{stg} | Storage Temperature | | -55 to +150 | $^\circ\text{C}$ |

Stresses exceeding those listed in the Maximum Ratings table may damage the device. If any of these limits are exceeded, device functionality should not be assumed, damage may occur and reliability may be affected.

ELECTRICAL CHARACTERISTICS ($T_A = 25^\circ\text{C}$)

| Symbol | Parameter | Conditions | Ratings | | | Unit |
|---------------|--------------------------|--|---------|------|-----|---------------|
| | | | Min | Typ | Max | |
| I_{CBO} | Collector Cutoff Current | $V_{CB} = 5$ V, $I_E = 0$ A | - | - | 1.0 | μA |
| I_{EBO} | Emitter Cutoff Current | $V_{EB} = 1$ V, $I_C = 0$ A | - | - | 1.0 | μA |
| h_{FE} | DC Current Gain | $V_{CE} = 5$ V, $I_C = 50$ mA | 60 | - | 150 | - |
| f_T | Gain-Bandwidth Product | $V_{CE} = 5$ V, $I_C = 50$ mA | 13 | 16 | - | GHz |
| $ S_{21e} ^2$ | Forward Transfer Gain | $V_{CE} = 5$ V, $I_C = 50$ mA, $f = 1$ GHz | - | 17.5 | - | dB |
| NF | Noise Figure | $V_{CE} = 1$ V, $I_C = 50$ mA, $f = 1$ GHz | - | 1.2 | 1.8 | dB |

Product parametric performance is indicated in the Electrical Characteristics for the listed test conditions, unless otherwise noted. Product performance may not be indicated by the Electrical Characteristics if operated under different conditions.

NOTE: Pay attention to handling since it is liable to be affected by static electricity due to the high-frequency process adopted.

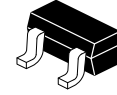

SC-82AB
CASE 419AK

ELECTRICAL CONNECTION

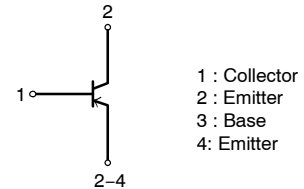

MARKING DIAGRAM

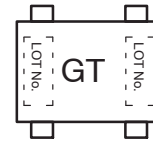

ORDERING INFORMATION

| Device | Package | Shipping [†] |
|--------------|------------------------------|-----------------------|
| MCH4020-TL-H | SC-82AB MCP4 (Pb-Free) | 3000 / Tape & Reel |

[†]For information on tape and reel specifications, including part orientation and tape sizes, please refer to our Tape and Reel Packaging Specifications Brochure, [BRD8011/D](#).

TYPICAL CHARACTERISTICS

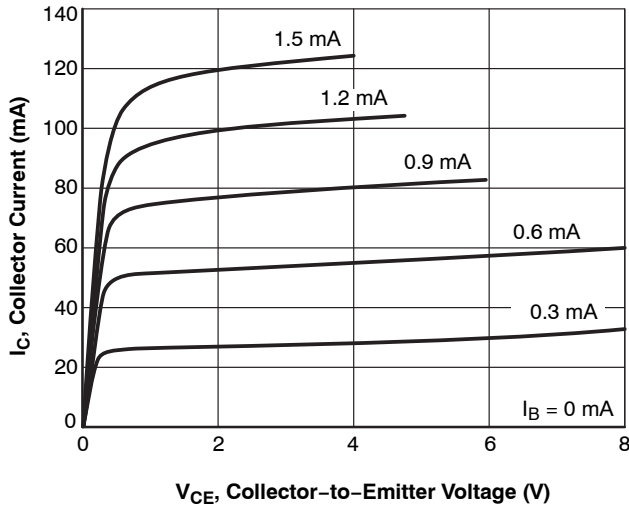

Figure 1. $I_C - V_{CE}$

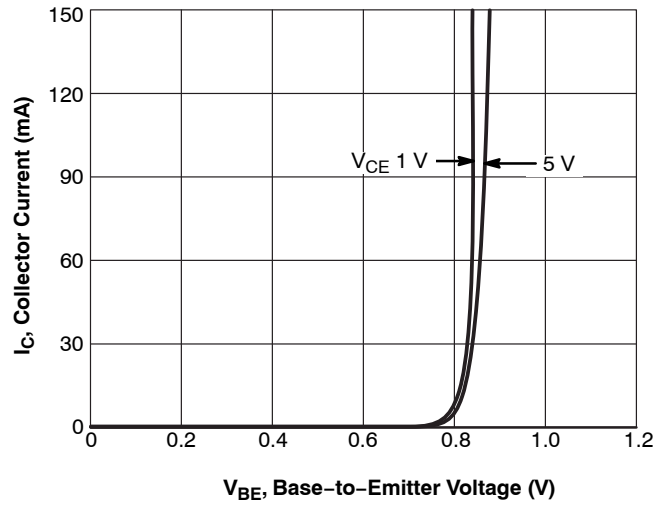

Figure 2. $I_C - V_{BE}$

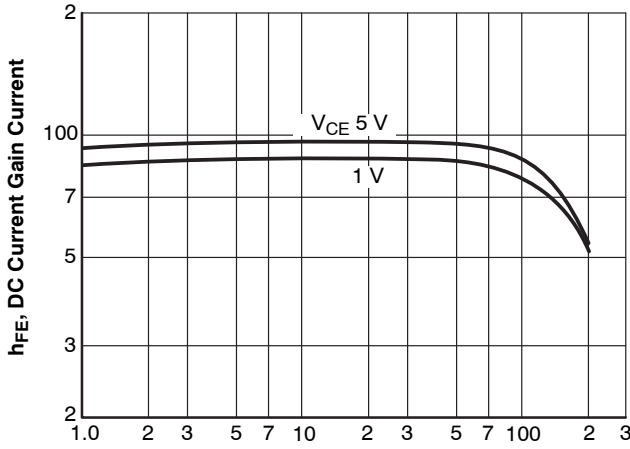

Figure 3. $h_{FE} - I_C$

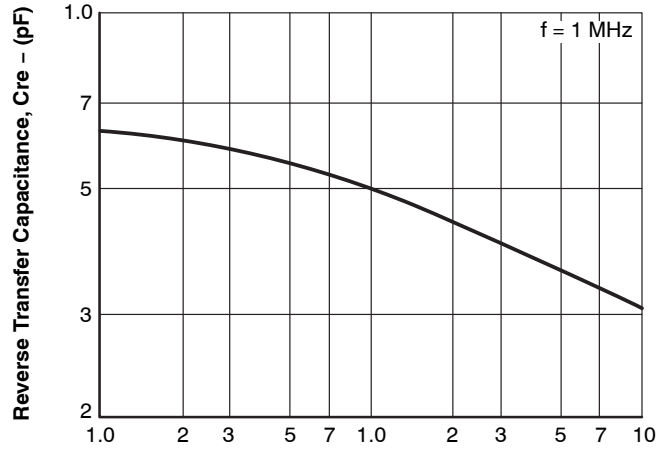

Figure 4. $C_{re} - V_{CB}$

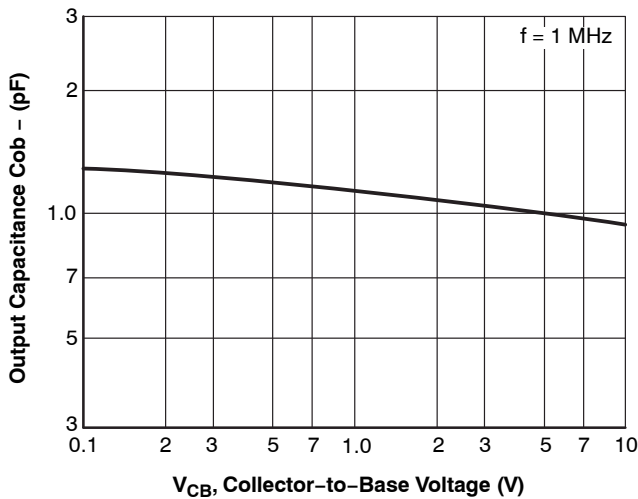

Figure 5. $C_{ob} - V_{CB}$

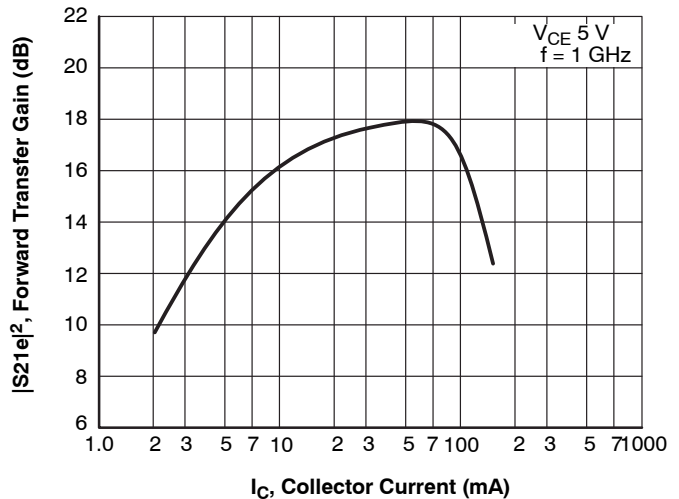

Figure 6. $V_{BE(sat)} - I_C$

TYPICAL CHARACTERISTICS (CONTINUED)

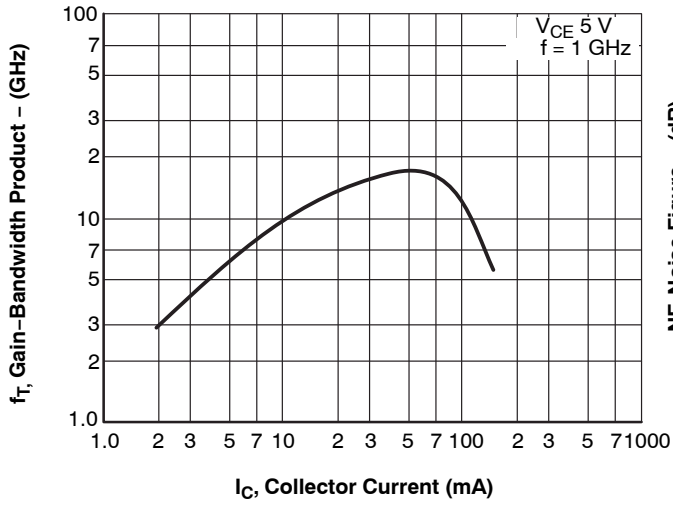

Figure 7. $f_T - I_C$

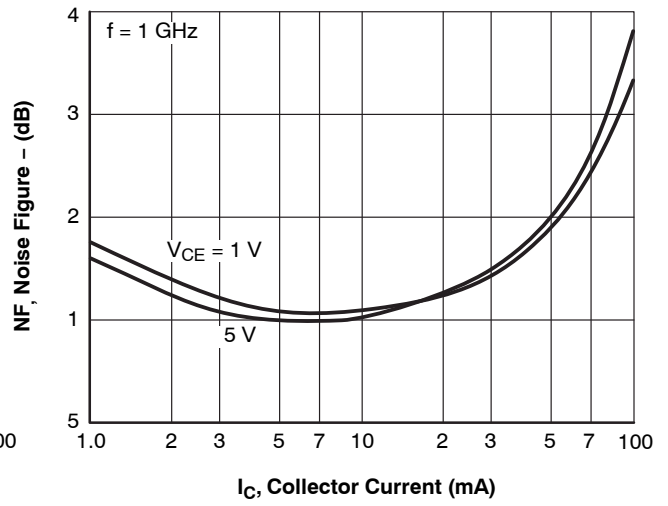

Figure 8. NF - I_C

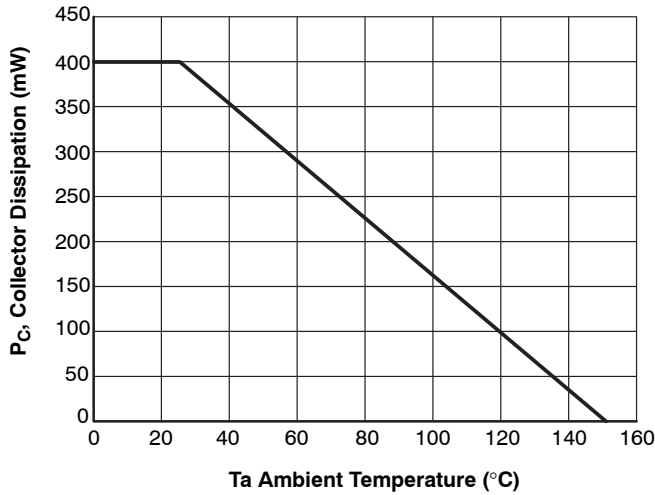

Figure 9. $P_C - T_a$

MCH4020

SPICE Parameters
model: Gummel-Poon

| Parameter | Value | Unit | Parameter | Value | Unit |
|-----------|--------|------|-----------|--------|------|
| IS | 2.155f | A | TF | 6.700p | S |
| BF | 122 | | XTF | 50.00f | |
| NF | 1.05 | | VTF | 750.0m | V |
| VAF | 8 | V | ITF | 50 | A |
| IKF | 206.4m | A | PTF | 200.0m | °C |
| ISE | 1.384p | A | CJC | 175.0f | F |
| NE | 2.278 | | VJC | 200.0f | V |
| BR | 14 | | MJC | 1.150p | |
| NR | 1.042 | | XCJC | 1 | |
| VAR | 4 | V | TR | 0 | S |
| IKR | 360.0m | A | FC | 500.0m | |
| ISC | 140.0f | A | CJS | 550.0f | F |
| NC | 1.6 | | VJS | 150.0m | V |
| RB | 2 | Ω | MJS | 136.0m | |
| IRB | 1.5 | A | Lfc | 110.0p | |
| RBM | 25.00m | Ω | Lwb | 850.0p | H |
| RE | 450.0m | Ω | Lfb | 73.0p | H |
| RC | 1.2 | Ω | Lwe | 145.0p | H |
| XTB | 0 | | Lfe | 280.0p | H |
| EG | 1.11 | eV | Cbc | 325.0f | F |
| XTI | 1 | | Ceb | 175.0f | F |
| CJE | 2.476p | F | Cce | 120.0f | F |
| VJE | 750.0m | V | | | |
| MJE | 10.00m | | | | |

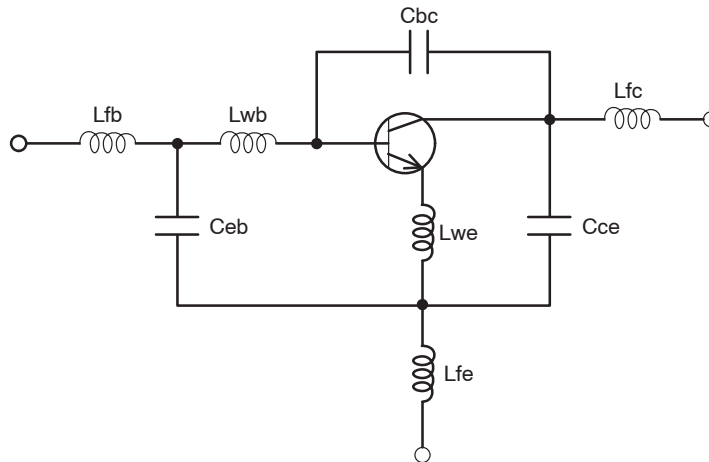

Figure 10. Schematic

NOTE: Information (including circuit diagrams and circuit parameters) herein is for example only; it is not guaranteed for volume production.

MCH4020

S Parameters (Common Emitter)

$V_{CE} = 1\text{ V}$, $I_C = 10\text{ mA}$

| Freq (MHz) | S11 | ∠S11 | S21 | ∠S21 | S12 | ∠S12 | S22 | ∠S22 |
|------------|-------|--------|--------|-------|-------|------|-------|--------|
| 200 | 0.664 | -88.0 | 17.728 | 131.6 | 0.046 | 52.6 | 0.753 | -60.7 |
| 400 | 0.674 | -130.4 | 11.682 | 107.8 | 0.061 | 40.5 | 0.567 | -93.8 |
| 600 | 0.681 | -147.2 | 8.523 | 95.7 | 0.071 | 38.0 | 0.513 | -106.8 |
| 800 | 0.666 | -160.0 | 6.411 | 87.9 | 0.076 | 38.4 | 0.445 | -118.0 |
| 1000 | 0.658 | -168.7 | 5.131 | 82.2 | 0.082 | 39.7 | 0.414 | -126.1 |
| 1200 | 0.657 | -175.3 | 4.280 | 77.4 | 0.087 | 41.3 | 0.393 | -132.2 |
| 1400 | 0.657 | 179.2 | 3.679 | 73.1 | 0.093 | 42.8 | 0.393 | -136.8 |
| 1600 | 0.657 | 174.3 | 3.228 | 69.2 | 0.100 | 44.4 | 0.375 | -141.0 |
| 1800 | 0.658 | 170.2 | 2.878 | 65.5 | 0.107 | 45.5 | 0.372 | -143.9 |
| 2000 | 0.659 | 166.6 | 2.608 | 62.0 | 0.114 | 46.5 | 0.372 | -146.8 |
| 2200 | 0.657 | 162.8 | 2.379 | 58.7 | 0.122 | 47.2 | 0.374 | -149.0 |
| 2400 | 0.658 | 159.4 | 2.193 | 55.3 | 0.130 | 47.6 | 0.378 | -151.2 |
| 2600 | 0.657 | 156.0 | 2.041 | 52.2 | 0.138 | 47.8 | 0.384 | -153.4 |
| 2800 | 0.657 | 152.7 | 1.909 | 49.0 | 0.146 | 47.9 | 0.390 | -154.6 |
| 3000 | 0.655 | 149.4 | 1.793 | 46.0 | 0.155 | 47.8 | 0.399 | -156.0 |
| 3200 | 0.652 | 146.0 | 1.693 | 42.9 | 0.163 | 47.5 | 0.409 | -157.2 |
| 3400 | 0.652 | 142.6 | 1.605 | 39.9 | 0.172 | 47.1 | 0.419 | -158.1 |
| 3600 | 0.651 | 139.0 | 1.528 | 37.1 | 0.180 | 46.6 | 0.432 | -158.9 |
| 3800 | 0.650 | 135.6 | 1.456 | 34.2 | 0.189 | 45.8 | 0.443 | -159.6 |
| 4000 | 0.650 | 131.8 | 1.393 | 31.3 | 0.198 | 45.0 | 0.455 | -160.2 |
| 4200 | 0.650 | 128.2 | 1.337 | 28.6 | 0.206 | 44.2 | 0.467 | -160.8 |
| 4400 | 0.652 | 124.6 | 1.281 | 26.0 | 0.215 | 43.3 | 0.479 | -161.2 |
| 4600 | 0.653 | 120.8 | 1.233 | 23.5 | 0.224 | 42.2 | 0.489 | -161.5 |
| 4800 | 0.654 | 117.3 | 1.185 | 20.8 | 0.232 | 41.1 | 0.499 | -161.7 |
| 5000 | 0.656 | 113.8 | 1.147 | 18.4 | 0.240 | 40.0 | 0.508 | -162.1 |

MCH4020

$V_{CE} = 1\text{ V}$, $I_C = 50\text{ mA}$

| Freq (MHz) | S11 | ∠S11 | S21 | ∠S21 | S12 | ∠S12 | S22 | ∠S22 |
|------------|-------|--------|--------|-------|-------|------|-------|--------|
| 200 | 0.652 | -152.6 | 22.719 | 111.2 | 0.024 | 50.4 | 0.545 | -102.4 |
| 400 | 0.694 | -168.0 | 12.745 | 95.1 | 0.034 | 54.6 | 0.466 | -133.3 |
| 600 | 0.693 | -174.1 | 8.865 | 86.6 | 0.045 | 58.6 | 0.442 | -140.7 |
| 800 | 0.694 | 179.3 | 6.618 | 81.7 | 0.055 | 61.5 | 0.422 | -149.5 |
| 1000 | 0.693 | 174.3 | 5.279 | 77.7 | 0.066 | 63.1 | 0.415 | -154.8 |
| 1200 | 0.697 | 170.1 | 4.399 | 74.2 | 0.078 | 64.0 | 0.410 | -159.2 |
| 1400 | 0.698 | 166.3 | 3.771 | 70.8 | 0.089 | 64.0 | 0.407 | -162.2 |
| 1600 | 0.700 | 162.8 | 3.307 | 67.7 | 0.100 | 63.8 | 0.405 | -165.0 |
| 1800 | 0.700 | 159.6 | 2.961 | 64.7 | 0.111 | 63.3 | 0.403 | -167.1 |
| 2000 | 0.700 | 156.8 | 2.683 | 61.8 | 0.122 | 62.7 | 0.405 | -169.1 |
| 2200 | 0.699 | 153.5 | 2.457 | 59.0 | 0.134 | 61.8 | 0.407 | -170.8 |
| 2400 | 0.699 | 150.5 | 2.260 | 56.0 | 0.145 | 60.6 | 0.410 | -172.2 |
| 2600 | 0.696 | 147.6 | 2.105 | 53.2 | 0.156 | 59.4 | 0.413 | -173.6 |
| 2800 | 0.696 | 144.6 | 1.976 | 50.5 | 0.167 | 58.2 | 0.416 | -174.4 |
| 3000 | 0.692 | 141.5 | 1.861 | 47.8 | 0.177 | 56.8 | 0.422 | -175.4 |
| 3200 | 0.688 | 138.3 | 1.761 | 45.0 | 0.188 | 55.4 | 0.429 | -175.9 |
| 3400 | 0.687 | 135.0 | 1.674 | 42.3 | 0.198 | 53.8 | 0.433 | -176.3 |
| 3600 | 0.684 | 131.6 | 1.598 | 39.7 | 0.209 | 52.4 | 0.441 | -176.5 |
| 3800 | 0.681 | 128.3 | 1.526 | 37.0 | 0.219 | 50.8 | 0.448 | -176.6 |
| 4000 | 0.680 | 124.7 | 1.462 | 34.3 | 0.229 | 49.2 | 0.456 | -176.6 |
| 4200 | 0.679 | 121.2 | 1.403 | 31.7 | 0.239 | 47.5 | 0.463 | -176.6 |
| 4400 | 0.678 | 117.7 | 1.351 | 29.3 | 0.248 | 46.0 | 0.470 | -176.4 |
| 4600 | 0.678 | 114.1 | 1.305 | 26.8 | 0.266 | 44.3 | 0.476 | -176.2 |
| 4800 | 0.676 | 110.7 | 1.260 | 24.3 | 0.257 | 42.5 | 0.480 | -176.1 |
| 5000 | 0.676 | 107.4 | 1.224 | 22.0 | 0.274 | 40.9 | 0.485 | -176.0 |

MCH4020

$V_{CE} = 1\text{ V}$, $I_C = 100\text{ mA}$

| Freq (MHz) | S11 | ∠S11 | S21 | ∠S21 | S12 | ∠S12 | S22 | ∠S22 |
|------------|-------|--------|--------|-------|-------|------|-------|--------|
| 200 | 0.797 | -170.2 | 11.994 | 103.3 | 0.023 | 46.0 | 0.462 | -142.7 |
| 400 | 0.821 | -178.6 | 6.267 | 90.3 | 0.032 | 55.8 | 0.471 | -159.7 |
| 600 | 0.814 | 176.9 | 4.334 | 82.5 | 0.044 | 60.5 | 0.456 | -162.5 |
| 800 | 0.816 | 172.4 | 3.254 | 78.0 | 0.056 | 63.5 | 0.453 | -167.1 |
| 1000 | 0.815 | 168.6 | 2.616 | 73.9 | 0.068 | 65.0 | 0.452 | -169.7 |
| 1200 | 0.819 | 165.2 | 2.196 | 70.2 | 0.080 | 65.6 | 0.452 | -172.2 |
| 1400 | 0.819 | 162.0 | 1.895 | 66.7 | 0.092 | 65.4 | 0.452 | -173.8 |
| 1600 | 0.821 | 158.9 | 1.674 | 63.1 | 0.104 | 64.8 | 0.453 | -175.5 |
| 1800 | 0.821 | 155.9 | 1.516 | 59.9 | 0.116 | 64.3 | 0.451 | -177.0 |
| 2000 | 0.821 | 153.3 | 1.378 | 56.8 | 0.128 | 63.4 | 0.455 | -178.3 |
| 2200 | 0.819 | 150.2 | 1.270 | 53.8 | 0.140 | 62.4 | 0.458 | -179.4 |
| 2400 | 0.818 | 147.4 | 1.178 | 50.7 | 0.152 | 61.1 | 0.462 | 179.5 |
| 2600 | 0.819 | 144.6 | 1.107 | 47.7 | 0.164 | 59.7 | 0.464 | 178.3 |
| 2800 | 0.814 | 141.6 | 1.048 | 44.9 | 0.176 | 58.3 | 0.469 | 177.7 |
| 3000 | 0.809 | 138.5 | 0.995 | 42.2 | 0.187 | 56.9 | 0.475 | 176.9 |
| 3200 | 0.805 | 135.5 | 0.949 | 39.4 | 0.198 | 55.3 | 0.481 | 176.5 |
| 3400 | 0.803 | 132.2 | 0.909 | 36.7 | 0.209 | 53.8 | 0.486 | 176.1 |
| 3600 | 0.799 | 128.9 | 0.875 | 34.2 | 0.221 | 52.2 | 0.493 | 175.9 |
| 3800 | 0.796 | 125.6 | 0.842 | 31.6 | 0.232 | 50.5 | 0.499 | 175.7 |
| 4000 | 0.794 | 122.1 | 0.812 | 29.1 | 0.242 | 48.7 | 0.505 | 175.6 |
| 4200 | 0.792 | 118.7 | 0.785 | 29.1 | 0.252 | 47.0 | 0.511 | 175.6 |
| 4400 | 0.790 | 115.3 | 0.762 | 24.5 | 0.262 | 45.3 | 0.516 | 175.7 |
| 4600 | 0.788 | 111.8 | 0.743 | 22.3 | 0.272 | 43.4 | 0.519 | 175.8 |
| 4800 | 0.787 | 108.3 | 0.722 | 20.0 | 0.281 | 41.6 | 0.522 | 175.8 |
| 5000 | 0.785 | 105.1 | 0.707 | 17.9 | 0.290 | 39.9 | 0.525 | 175.8 |

MCH4020

$V_{CE} = 3\text{ V}$, $I_C = 10\text{ mA}$

| Freq (MHz) | S11 | ∠S11 | S21 | ∠S21 | S12 | ∠S12 | S22 | ∠S22 |
|------------|-------|--------|--------|-------|-------|------|-------|--------|
| 200 | 0.667 | -73.4 | 19.421 | 137.2 | 0.036 | 59.5 | 0.807 | -46.2 |
| 400 | 0.654 | -117.7 | 13.670 | 112.4 | 0.051 | 46.8 | 0.610 | -74.6 |
| 600 | 0.657 | -137.3 | 10.173 | 99.3 | 0.060 | 43.7 | 0.541 | -86.7 |
| 800 | 0.635 | -152.0 | 7.684 | 90.5 | 0.066 | 43.4 | 0.452 | -96.5 |
| 1000 | 0.624 | -162.0 | 6.158 | 84.2 | 0.071 | 44.2 | 0.407 | -104.3 |
| 1200 | 0.621 | -169.6 | 5.138 | 79.1 | 0.076 | 45.7 | 0.376 | -110.1 |
| 1400 | 0.620 | -175.7 | 4.400 | 74.5 | 0.082 | 47.0 | 0.360 | -114.7 |
| 1600 | 0.619 | 178.9 | 3.867 | 70.4 | 0.088 | 48.7 | 0.347 | -119.0 |
| 1800 | 0.620 | 174.4 | 3.431 | 66.7 | 0.095 | 49.8 | 0.343 | -122.2 |
| 2000 | 0.621 | 170.6 | 3.103 | 63.0 | 0.101 | 50.9 | 0.341 | -125.5 |
| 2200 | 0.620 | 166.6 | 2.828 | 59.5 | 0.108 | 51.7 | 0.343 | -128.1 |
| 2400 | 0.621 | 163.0 | 2.602 | 56.1 | 0.116 | 52.3 | 0.347 | -130.7 |
| 2600 | 0.620 | 159.4 | 2.419 | 52.9 | 0.124 | 52.6 | 0.353 | -133.3 |
| 2800 | 0.622 | 156.1 | 2.253 | 49.6 | 0.131 | 52.8 | 0.361 | -135.1 |
| 3000 | 0.620 | 152.7 | 2.112 | 46.5 | 0.139 | 52.8 | 0.372 | -137.1 |
| 3200 | 0.618 | 149.2 | 1.990 | 43.3 | 0.148 | 52.6 | 0.384 | -138.9 |
| 3400 | 0.619 | 145.6 | 1.881 | 40.3 | 0.156 | 52.3 | 0.396 | -140.4 |
| 3600 | 0.618 | 142.1 | 1.784 | 37.3 | 0.164 | 51.9 | 0.412 | -141.7 |
| 3800 | 0.618 | 138.5 | 1.696 | 34.3 | 0.173 | 51.2 | 0.426 | -143.0 |
| 4000 | 0.618 | 134.7 | 1.618 | 31.4 | 0.182 | 50.5 | 0.441 | -144.1 |
| 4200 | 0.620 | 130.9 | 1.549 | 28.6 | 0.191 | 49.6 | 0.456 | -145.3 |
| 4400 | 0.621 | 127.2 | 1.480 | 25.9 | 0.199 | 48.7 | 0.471 | -146.2 |
| 4600 | 0.623 | 123.4 | 1.419 | 23.2 | 0.208 | 47.7 | 0.485 | -147.0 |
| 4800 | 0.626 | 119.8 | 1.359 | 20.5 | 0.216 | 46.7 | 0.498 | -147.7 |
| 5000 | 0.629 | 116.2 | 1.309 | 18.0 | 0.224 | 45.6 | 0.511 | -148.5 |

MCH4020

S Parameter (Common Emitter)

$V_{CE} = 3\text{ V}$, $I_C = 50\text{ mA}$

| Freq (MHz) | S11 | ∠S11 | S21 | ∠S21 | S12 | ∠S12 | S22 | ∠S22 |
|------------|-------|--------|--------|-------|-------|------|-------|--------|
| 200 | 0.516 | -135.8 | 31.907 | 119.4 | 0.020 | 59.2 | 0.602 | -73.9 |
| 400 | 0.593 | -158.7 | 17.954 | 99.0 | 0.029 | 60.4 | 0.444 | -104.5 |
| 600 | 0.602 | -166.8 | 12.350 | 89.5 | 0.039 | 63.6 | 0.404 | -113.3 |
| 800 | 0.606 | -174.8 | 9.160 | 83.7 | 0.049 | 65.9 | 0.359 | -123.7 |
| 1000 | 0.608 | 179.2 | 7.261 | 79.3 | 0.059 | 67.0 | 0.341 | -131.0 |
| 1200 | 0.612 | 174.4 | 6.025 | 75.7 | 0.069 | 67.5 | 0.327 | -136.6 |
| 1400 | 0.614 | 170.2 | 5.149 | 72.2 | 0.079 | 67.4 | 0.321 | -140.6 |
| 1600 | 0.615 | 166.4 | 4.503 | 69.0 | 0.089 | 67.2 | 0.316 | -144.0 |
| 1800 | 0.618 | 162.9 | 4.004 | 66.0 | 0.100 | 66.4 | 0.314 | -146.9 |
| 2000 | 0.619 | 159.8 | 3.619 | 63.1 | 0.110 | 65.8 | 0.316 | -149.3 |
| 2200 | 0.618 | 156.5 | 3.299 | 60.1 | 0.120 | 64.9 | 0.319 | -151.3 |
| 2400 | 0.618 | 153.5 | 3.035 | 57.3 | 0.130 | 63.9 | 0.322 | -152.9 |
| 2600 | 0.617 | 150.5 | 2.816 | 54.4 | 0.141 | 62.7 | 0.326 | -154.5 |
| 2800 | 0.617 | 147.4 | 2.630 | 51.7 | 0.150 | 61.6 | 0.334 | -155.5 |
| 3000 | 0.614 | 144.2 | 2.469 | 49.0 | 0.160 | 60.3 | 0.342 | -156.7 |
| 3200 | 0.611 | 141.0 | 2.328 | 46.1 | 0.170 | 58.9 | 0.351 | -157.4 |
| 3400 | 0.611 | 137.6 | 2.204 | 43.4 | 0.180 | 57.5 | 0.360 | -157.9 |
| 3600 | 0.609 | 134.3 | 2.095 | 40.7 | 0.189 | 56.1 | 0.372 | -158.3 |
| 3800 | 0.608 | 130.8 | 1.995 | 38.0 | 0.199 | 54.7 | 0.383 | -158.6 |
| 4000 | 0.606 | 127.2 | 1.906 | 35.3 | 0.209 | 53.1 | 0.395 | -158.7 |
| 4200 | 0.607 | 123.6 | 1.824 | 32.6 | 0.218 | 51.5 | 0.407 | -158.8 |
| 4400 | 0.607 | 120.1 | 1.749 | 30.1 | 0.226 | 49.9 | 0.419 | -158.9 |
| 4600 | 0.607 | 116.5 | 1.681 | 27.6 | 0.235 | 48.3 | 0.430 | -158.8 |
| 4800 | 0.608 | 113.0 | 1.616 | 25.0 | 0.243 | 46.8 | 0.440 | -158.9 |
| 5000 | 0.608 | 109.6 | 1.560 | 22.6 | 0.251 | 45.2 | 0.450 | -159.0 |

MCH4020

$V_{CE} = 3\text{ V}$, $I_C = 100\text{ mA}$

| Freq (MHz) | S11 | ∠S11 | S21 | ∠S21 | S12 | ∠S12 | S22 | ∠S22 |
|------------|-------|--------|--------|-------|-------|------|-------|--------|
| 200 | 0.577 | -155.5 | 28.271 | 114.9 | 0.017 | 60.5 | 0.496 | -77.8 |
| 400 | 0.645 | -169.1 | 15.432 | 96.4 | 0.025 | 64.9 | 0.367 | -105.8 |
| 600 | 0.649 | -174.6 | 10.567 | 87.2 | 0.036 | 68.7 | 0.339 | -111.9 |
| 800 | 0.656 | 179.3 | 7.841 | 81.8 | 0.046 | 70.5 | 0.306 | -121.4 |
| 1000 | 0.658 | 174.4 | 6.227 | 77.4 | 0.056 | 71.3 | 0.295 | -127.8 |
| 1200 | 0.663 | 170.4 | 5.172 | 73.6 | 0.066 | 71.6 | 0.287 | -132.7 |
| 1400 | 0.666 | 166.8 | 4.421 | 70.1 | 0.076 | 71.2 | 0.285 | -136.0 |
| 1600 | 0.668 | 163.4 | 3.860 | 66.9 | 0.087 | 70.6 | 0.285 | -138.9 |
| 1800 | 0.671 | 160.2 | 3.443 | 63.7 | 0.097 | 69.8 | 0.287 | -141.5 |
| 2000 | 0.672 | 157.5 | 3.108 | 60.7 | 0.107 | 69.1 | 0.292 | -143.6 |
| 2200 | 0.671 | 154.3 | 2.835 | 57.5 | 0.118 | 68.1 | 0.297 | -145.5 |
| 2400 | 0.672 | 151.4 | 2.606 | 54.5 | 0.128 | 67.0 | 0.304 | -147.0 |
| 2600 | 0.671 | 148.6 | 2.419 | 51.5 | 0.139 | 65.7 | 0.311 | -148.5 |
| 2800 | 0.671 | 145.6 | 2.260 | 48.7 | 0.148 | 64.4 | 0.321 | -149.6 |
| 3000 | 0.669 | 142.6 | 2.122 | 45.9 | 0.159 | 63.1 | 0.332 | -150.9 |
| 3200 | 0.665 | 139.5 | 2.001 | 42.9 | 0.169 | 61.7 | 0.345 | -151.7 |
| 3400 | 0.666 | 136.2 | 1.895 | 40.1 | 0.179 | 60.2 | 0.357 | -152.5 |
| 3600 | 0.664 | 132.9 | 1.800 | 37.3 | 0.189 | 58.6 | 0.371 | -153.0 |
| 3800 | 0.663 | 129.5 | 1.713 | 34.5 | 0.199 | 57.1 | 0.385 | -153.6 |
| 4000 | 0.662 | 126.0 | 1.635 | 31.7 | 0.209 | 55.5 | 0.399 | -154.0 |
| 4200 | 0.663 | 122.5 | 1.562 | 29.0 | 0.218 | 53.9 | 0.414 | -154.4 |
| 4400 | 0.663 | 119.1 | 1.497 | 26.4 | 0.227 | 52.3 | 0.428 | -154.8 |
| 4600 | 0.663 | 115.5 | 1.438 | 23.9 | 0.236 | 50.6 | 0.441 | -155.0 |
| 4800 | 0.664 | 112.0 | 1.381 | 21.3 | 0.245 | 48.9 | 0.453 | -155.3 |
| 5000 | 0.664 | 108.7 | 1.333 | 18.9 | 0.253 | 47.3 | 0.464 | -155.7 |

MCH4020

S Parameter (Common Emitter)

$V_{CE} = 5\text{ V}$, $I_C = 10\text{ mA}$

| Freq (MHz) | S11 | ∠S11 | S21 | ∠S21 | S12 | ∠S12 | S22 | ∠S22 |
|------------|-------|--------|--------|-------|-------|------|-------|--------|
| 200 | 0.674 | -68.7 | 19.895 | 138.9 | 0.032 | 61.8 | 0.826 | -41.4 |
| 400 | 0.653 | -112.8 | 14.318 | 114.0 | 0.047 | 49.2 | 0.632 | -67.8 |
| 600 | 0.651 | -133.4 | 10.744 | 100.5 | 0.057 | 45.9 | 0.560 | -79.3 |
| 800 | 0.626 | -148.8 | 8.133 | 91.4 | 0.062 | 45.3 | 0.466 | -88.2 |
| 1000 | 0.613 | -159.3 | 6.522 | 84.8 | 0.067 | 46.0 | 0.415 | -95.5 |
| 1200 | 0.610 | -167.2 | 5.440 | 79.6 | 0.072 | 47.5 | 0.382 | -100.9 |
| 1400 | 0.607 | -173.5 | 4.659 | 74.9 | 0.078 | 48.7 | 0.363 | -105.3 |
| 1600 | 0.606 | -179.1 | 4.091 | 70.7 | 0.084 | 50.5 | 0.349 | -109.4 |
| 1800 | 0.608 | 176.2 | 3.630 | 66.9 | 0.090 | 51.6 | 0.344 | -112.7 |
| 2000 | 0.609 | 172.2 | 3.280 | 63.2 | 0.096 | 52.7 | 0.341 | -116.0 |
| 2200 | 0.608 | 168.1 | 2.988 | 59.7 | 0.103 | 53.5 | 0.343 | -118.8 |
| 2400 | 0.608 | 164.5 | 2.749 | 56.2 | 0.110 | 54.2 | 0.347 | -121.6 |
| 2600 | 0.608 | 160.9 | 2.553 | 52.9 | 0.118 | 54.6 | 0.353 | -124.4 |
| 2800 | 0.610 | 157.5 | 2.377 | 49.6 | 0.125 | 54.9 | 0.361 | -126.4 |
| 3000 | 0.607 | 154.0 | 2.225 | 46.5 | 0.133 | 54.9 | 0.372 | -128.8 |
| 3200 | 0.606 | 150.5 | 2.095 | 43.2 | 0.141 | 54.9 | 0.385 | -130.8 |
| 3400 | 0.607 | 146.9 | 1.979 | 40.2 | 0.150 | 54.6 | 0.398 | -132.6 |
| 3600 | 0.607 | 143.3 | 1.875 | 37.1 | 0.158 | 54.2 | 0.414 | -134.3 |
| 3800 | 0.607 | 139.7 | 1.780 | 34.1 | 0.167 | 53.6 | 0.430 | -136.0 |
| 4000 | 0.608 | 135.9 | 1.697 | 31.1 | 0.175 | 52.9 | 0.446 | -137.4 |
| 4200 | 0.610 | 132.0 | 1.623 | 28.3 | 0.184 | 52.1 | 0.461 | -138.8 |
| 4400 | 0.612 | 128.3 | 1.549 | 25.5 | 0.193 | 51.1 | 0.477 | -140.0 |
| 4600 | 0.613 | 124.5 | 1.484 | 22.8 | 0.202 | 50.1 | 0.492 | -141.1 |
| 4800 | 0.617 | 120.7 | 1.419 | 20.0 | 0.210 | 49.1 | 0.507 | -142.0 |
| 5000 | 0.620 | 117.1 | 1.364 | 17.5 | 0.218 | 48.0 | 0.520 | -143.0 |

MCH4020

S Parameter (Common Emitter)

$V_{CE} = 5\text{ V}$, $I_C = 50\text{ mA}$

| Freq (MHz) | S11 | ∠S11 | S21 | ∠S21 | S12 | ∠S12 | S22 | ∠S22 |
|------------|-------|--------|--------|-------|-------|------|-------|--------|
| 200 | 0.489 | -128.9 | 33.664 | 121.6 | 0.019 | 61.0 | 0.625 | -65.5 |
| 400 | 0.568 | -154.7 | 19.269 | 100.2 | 0.028 | 61.3 | 0.449 | -94.0 |
| 600 | 0.579 | -163.6 | 13.271 | 90.3 | 0.038 | 64.6 | 0.404 | -102.5 |
| 800 | 0.583 | -172.3 | 9.829 | 84.2 | 0.047 | 66.7 | 0.350 | -112.6 |
| 1000 | 0.584 | -178.7 | 7.784 | 79.6 | 0.056 | 67.8 | 0.325 | -119.9 |
| 1200 | 0.589 | 176.2 | 6.443 | 75.8 | 0.066 | 68.5 | 0.308 | -125.6 |
| 1400 | 0.591 | 171.8 | 5.505 | 72.3 | 0.076 | 68.4 | 0.300 | -129.7 |
| 1600 | 0.593 | 167.9 | 4.817 | 69.1 | 0.085 | 68.1 | 0.295 | -133.2 |
| 1800 | 0.595 | 164.3 | 4.280 | 66.0 | 0.095 | 67.6 | 0.292 | -136.3 |
| 2000 | 0.596 | 161.2 | 3.857 | 63.1 | 0.105 | 67.0 | 0.294 | -138.9 |
| 2200 | 0.596 | 157.8 | 3.517 | 60.1 | 0.115 | 66.1 | 0.296 | -141.1 |
| 2400 | 0.596 | 154.7 | 3.234 | 57.2 | 0.124 | 65.1 | 0.300 | -142.9 |
| 2600 | 0.595 | 151.7 | 3.000 | 54.3 | 0.134 | 63.9 | 0.306 | -144.7 |
| 2800 | 0.596 | 148.5 | 2.799 | 51.5 | 0.144 | 62.8 | 0.313 | -145.9 |
| 3000 | 0.593 | 145.4 | 2.625 | 48.7 | 0.154 | 61.6 | 0.323 | -147.3 |
| 3200 | 0.591 | 142.2 | 2.472 | 45.9 | 0.163 | 60.2 | 0.334 | -148.3 |
| 3400 | 0.591 | 138.8 | 2.340 | 43.1 | 0.173 | 59.0 | 0.344 | -149.0 |
| 3600 | 0.589 | 135.4 | 2.221 | 40.4 | 0.182 | 57.7 | 0.358 | -149.6 |
| 3800 | 0.589 | 131.9 | 2.114 | 37.6 | 0.191 | 56.2 | 0.371 | -150.2 |
| 4000 | 0.588 | 128.3 | 2.017 | 34.9 | 0.201 | 54.6 | 0.385 | -150.6 |
| 4200 | 0.588 | 124.7 | 1.929 | 32.2 | 0.209 | 53.1 | 0.399 | -150.9 |
| 4400 | 0.589 | 121.1 | 1.847 | 29.6 | 0.218 | 51.7 | 0.412 | -151.3 |
| 4600 | 0.590 | 117.5 | 1.773 | 27.1 | 0.227 | 50.1 | 0.426 | -151.5 |
| 4800 | 0.590 | 113.9 | 1.702 | 24.4 | 0.235 | 48.6 | 0.438 | -151.7 |
| 5000 | 0.592 | 110.6 | 1.642 | 22.0 | 0.243 | 47.0 | 0.450 | -152.0 |

MECHANICAL CASE OUTLINE
PACKAGE DIMENSIONS

SC-82AB / MCP4
CASE 419AK
ISSUE O

DATE 30 NOV 2011

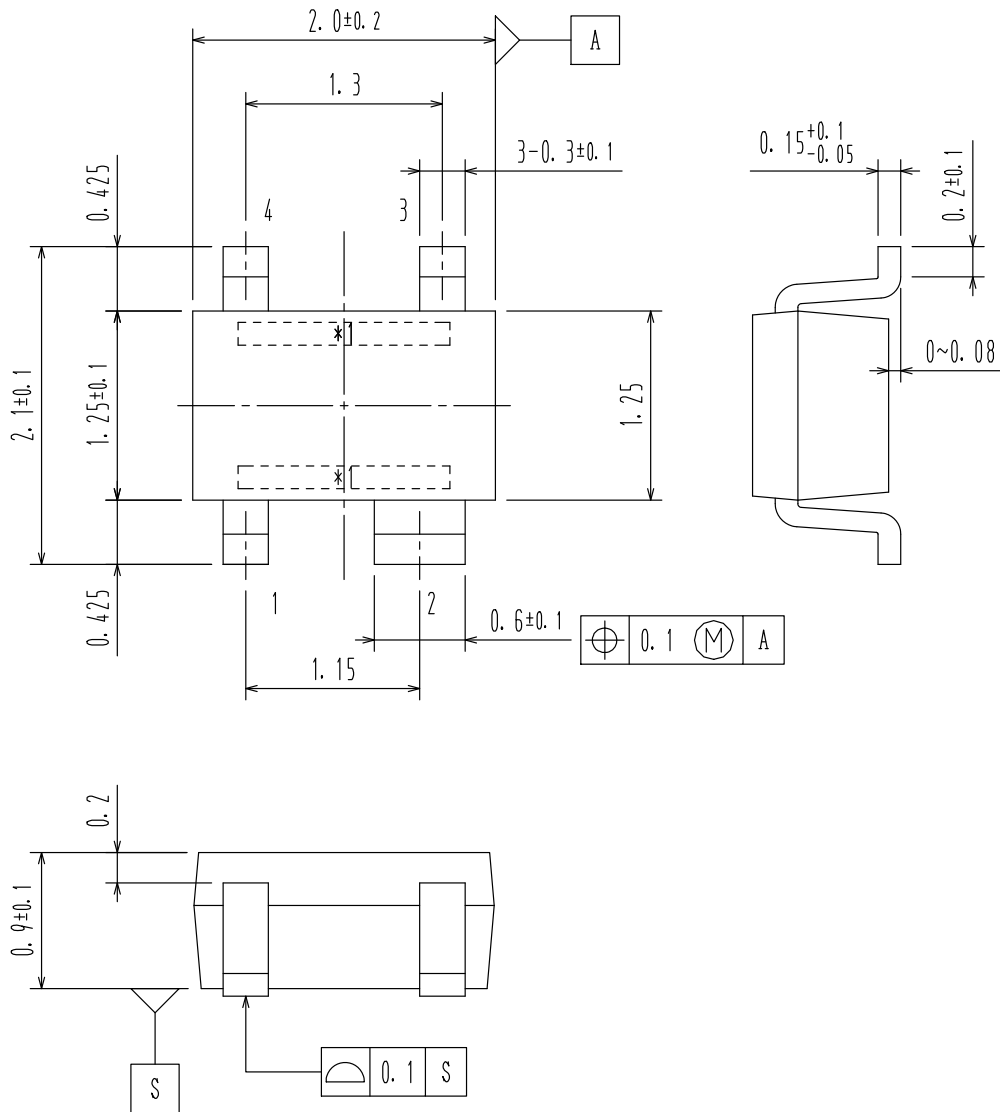

| | | |
|-------------------------|-----------------------|---|
| DOCUMENT NUMBER: | 98AON65443E | Electronic versions are uncontrolled except when accessed directly from the Document Repository. Printed versions are uncontrolled except when stamped "CONTROLLED COPY" in red. |
| DESCRIPTION: | SC-82AB / MCP4 | PAGE 1 OF 1 |

ON Semiconductor and **ON** are trademarks of Semiconductor Components Industries, LLC dba ON Semiconductor or its subsidiaries in the United States and/or other countries. ON Semiconductor reserves the right to make changes without further notice to any products herein. ON Semiconductor makes no warranty, representation or guarantee regarding the suitability of its products for any particular purpose, nor does ON Semiconductor assume any liability arising out of the application or use of any product or circuit, and specifically disclaims any and all liability, including without limitation special, consequential or incidental damages. ON Semiconductor does not convey any license under its patent rights nor the rights of others.

onsemi, **Onsemi**, and other names, marks, and brands are registered and/or common law trademarks of Semiconductor Components Industries, LLC dba "**onsemi**" or its affiliates and/or subsidiaries in the United States and/or other countries. **onsemi** owns the rights to a number of patents, trademarks, copyrights, trade secrets, and other intellectual property. A listing of **onsemi**'s product/patent coverage may be accessed at www.onsemi.com/site/pdf/Patent-Marking.pdf. **onsemi** reserves the right to make changes at any time to any products or information herein, without notice. The information herein is provided "as-is" and **onsemi** makes no warranty, representation or guarantee regarding the accuracy of the information, product features, availability, functionality, or suitability of its products for any particular purpose, nor does **onsemi** assume any liability arising out of the application or use of any product or circuit, and specifically disclaims any and all liability, including without limitation special, consequential or incidental damages. Buyer is responsible for its products and applications using **onsemi** products, including compliance with all laws, regulations and safety requirements or standards, regardless of any support or applications information provided by **onsemi**. "Typical" parameters which may be provided in **onsemi** data sheets and/or specifications can and do vary in different applications and actual performance may vary over time. All operating parameters, including "Typicals" must be validated for each customer application by customer's technical experts. **onsemi** does not convey any license under any of its intellectual property rights nor the rights of others. **onsemi** products are not designed, intended, or authorized for use as a critical component in life support systems or any FDA Class 3 medical devices or medical devices with a same or similar classification in a foreign jurisdiction or any devices intended for implantation in the human body. Should Buyer purchase or use **onsemi** products for any such unintended or unauthorized application, Buyer shall indemnify and hold **onsemi** and its officers, employees, subsidiaries, affiliates, and distributors harmless against all claims, costs, damages, and expenses, and reasonable attorney fees arising out of, directly or indirectly, any claim of personal injury or death associated with such unintended or unauthorized use, even if such claim alleges that **onsemi** was negligent regarding the design or manufacture of the part. **onsemi** is an Equal Opportunity/Affirmative Action Employer. This literature is subject to all applicable copyright laws and is not for resale in any manner.

ADDITIONAL INFORMATION

TECHNICAL PUBLICATIONS:

Technical Library: www.onsemi.com/design/resources/technical-documentation
onsemi Website: www.onsemi.com

ONLINE SUPPORT: www.onsemi.com/support

For additional information, please contact your local Sales Representative at www.onsemi.com/support/sales