

Current-Shunt Monitors, 40 V Common Mode, Unidirectional, Single, Dual

NCS21673, NCV21673, NCS21674, NCV21674

The NCS21673 and NCS21674 are a series of current sense amplifiers offered in gains of 20, 50, 100 and 200 V/V. These parts can measure voltage across shunts at common mode voltages from -0.1 V to 40 V , independent of supply voltage. This helps measuring of fast transients and allows the same type of part to be used for high side and low side current sensing. These devices can operate from a single 2.7 V to 5.5 V power supply. With a -3 dB BW of up to 350 kHz and a Slew Rate of $2\text{ V}/\mu\text{s}$ typical, the fast detection of current changes is ensured. These parts are available in TSOP-5 and Micro-8 packages. The dual version makes current sensing in multiple points of a system both space and cost effective.

Features

- Wide Common Mode Input Range: -0.1 V to 40 V
- Supply Voltage Range: 2.7 V to 5.5 V
- Low Offset Voltage
- Low Offset Drift
- Low Current Consumption: $300\text{ }\mu\text{A}$ max per channel
- NCV Prefix for Automotive Grade 1 and Other Applications Requiring Unique Site and Control Change Requirements; AEC-Q100 Qualified and PPAP Capable
- These Devices are Pb-Free, Halogen Free/BFR Free and are RoHS Compliant

Applications

- High-Side Current Sensing
- Low-Side Current Sensing
- Power Management
- Automotive

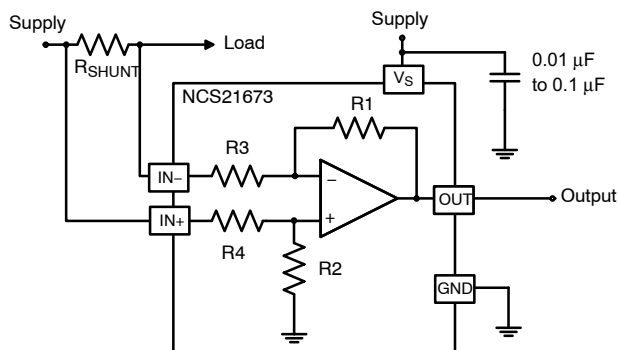
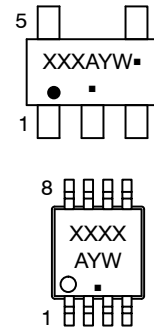

Figure 1. Example Application Schematic of High-Side Current Sensing

MARKING DIAGRAMS



- XXX = Specific Device Code
- A = Assembly Location
- Y = Year
- W = Work Week
- = Pb-Free Package

(Note: Microdot may be in either location)

PIN CONNECTIONS

See pin connections on page 2 of this data sheet.

ORDERING INFORMATION

See detailed ordering and shipping information on page 14 of this data sheet.

NCS21673, NCV21673, NCS21674, NCV21674

PIN FUNCTION DESCRIPTION

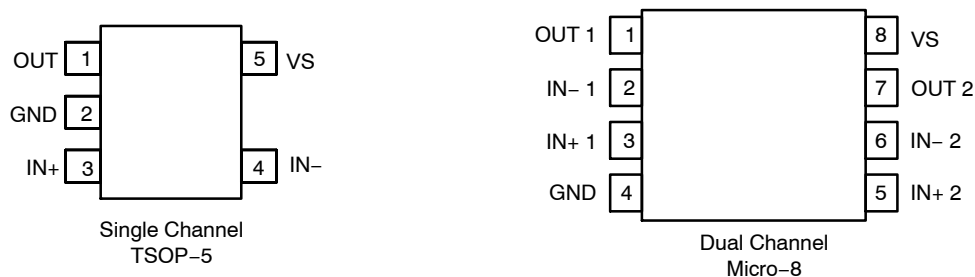

Figure 2. Pin Function Description

PIN DESCRIPTION

Pin Name	Type	Description
IN+	Input	This pin is connected to the positive side of the sense resistor or current shunt.
IN-	Input	This pin is connected to the negative side of the sense resistor or current shunt.
OUT	Output	The output pin provides a low impedance voltage output.
V _S	Supply	This is the positive supply pin that provides power to the internal circuitry. An external bypass capacitor of 0.1 μF is recommended to be placed as close as possible to this pin.
GND	Supply	This is the negative supply rail of the circuit.

MAXIMUM RATINGS

Parameter	Symbol	Rating	Unit
Supply Voltage (Note 1)	V _S	-0.3 to 5.5	V
Analog Inputs	Differential (V _{IN+})-(V _{IN-}) (Note 2)	±42	Analog Inputs
	Common-Mode (Note 2)	-0.3 to +42	
Output	V _{OUT}	GND-0.3 to (V _S) +0.3	V
Maximum Output Current	I _{OUT}	8	mA
Input Current into Any Pin	I _{IN}	±10	mA
Maximum Junction Temperature	T _{J(max)}	+150	°C
Storage Temperature Range	T _{STG}	-65 to +150	°C
ESD Capability, Human Body Model (Note 3)	HBM	±2000	V
Charged Device Model (Note 3)	CDM	±1000	V
Latch-up Current (Note 4)		±100	mA

Stresses exceeding those listed in the Maximum Ratings table may damage the device. If any of these limits are exceeded, device functionality should not be assumed, damage may occur and reliability may be affected.

1. Refer to ELECTRICAL CHARACTERISTICS, RECOMMENDED OPERATING RANGES and/or APPLICATION INFORMATION for safe operating parameters.
2. Input voltage at any pin may exceed the voltage shown if current at that pin is limited to ±10 mA
3. This device series incorporates ESD protection and is tested by the following methods: ESD Human Body Model tested per JEDEC standard JS-001-2017
ESD Charged Device Model tested per JEDEC standard JS-002-2014
4. Latch-up Current tested per JEDEC standard: JESD78E

THERMAL CHARACTERISTICS

Parameter	Symbol	Package	Value	Unit
Thermal Resistance, Junction-to-Air (Notes 5, 6)	θ _{JA}	TSOP-5 / SOT23-5	208	°C/W
		Micro8 / MSOP-8	162	

5. Refer to ELECTRICAL CHARACTERISTICS, RECOMMENDED OPERATING RANGES and/or APPLICATION INFORMATION for safe operating parameters
6. Values based on copper area of 645 mm² (or 1 in²) of 1 oz copper thickness and FR4 PCB substrate

NCS21673, NCV21673, NCS21674, NCV21674

RECOMMENDED OPERATING RANGES

Parameter	Symbol	Conditions	Min	Max	Unit
Operating Temperature	T_A	NCS prefix	-40	125	°C
		NCV prefix	-40	150	
Common Mode Input Voltage	V_{CM}	Full temperature range	-0.1	40	V
Supply Voltage	V_S	Full temperature range	2.7	5.5	V

Functional operation above the stresses listed in the Recommended Operating Ranges is not implied. Extended exposure to stresses beyond the Recommended Operating Ranges limits may affect device reliability.

*Operation up to $T_A = 150^\circ\text{C}$ is permitted, provided the total power dissipation is limited to prevent the junction temperature from exceeding the 150°C maximum limit.

ELECTRICAL CHARACTERISTICS

At $T_A = +25^\circ\text{C}$, $V_{SENSE} = (V_{IN+}) - (V_{IN-})$, $V_S = 5\text{ V}$, $V_{IN+} = 12\text{ V}$, unless otherwise noted. **Boldface** limits apply over the specified temperature range, $T_A = -40^\circ\text{C}$ to 125°C unless otherwise noted, guaranteed by characterization and/or design.

Parameter	Symbol	Conditions	Min	Typ	Max	Unit
-----------	--------	------------	-----	-----	-----	------

INPUT

Common Mode Rejection Ratio (RTI)*	CMRR	$V_{IN+} = -0.1\text{ V}$ to 40 V , $V_{SENSE} = 0\text{ mV}$ for G20, G50 and G100 $V_{SENSE} = 5\text{ mV}$ for G200	NCS21673	G = 20	-	100	-	dB
					86	-	-	
			NCS21674	G = 20	-	100	-	
					84	-	-	
			NCS2167x	G = 50	-	100	-	
					86	-	-	
				G = 100	-	110	-	
					96	-	-	
				G = 200	-	120	-	
100	-	-						
Input Offset Voltage (RTI)*	V_{OS}	$T_A = 25^\circ\text{C}$, $(V_{IN+}) = (V_{IN-}) = 12\text{ V}$	NCS21673	G = 20	-	± 100	± 500	μV
					86	± 100	± 850	
			NCS21674	G = 20	-	± 100	± 850	
					84	± 100	± 500	
			NCS2167x	G = 50	-	± 100	± 550	
				G = 100	-	± 100	± 500	
		G = 200	-	± 100	± 500			
		$T_A = 25^\circ\text{C}$, $(V_{IN+}) = (V_{IN-}) = 0\text{ V}$	NCS21673	G = 20	-	± 25	± 175	
					86	± 25	± 175	
			NCS21674	G = 20	-	± 25	± 175	
					84	± 25	± 175	
			NCS2167x	G = 50	-	± 25	± 175	
G = 100	-			± 25	± 175			
G = 200	-	± 25	± 210					
Input Offset Voltage Drift vs. Temperature (RTI)*	dV_{OS}/dT	$T_A = -40^\circ\text{C}$ to $+125^\circ\text{C}$	NCS21673		-	± 0.1	± 0.5	$\mu\text{V}/^\circ\text{C}$
			NCS21674		-	± 0.2	± 1	
Power Supply Rejection Ratio (RTI)*	PSRR	$V_S = 2.7\text{ V}$ to 5.5 V , $V_{SENSE} = 10\text{ mV}$ for G20, G50 and G100 $V_{SENSE} = 5\text{ mV}$ for G200	NCS21673		-	2	20	$\mu\text{V}/\text{V}$
			NCS21674		-	8	40	
Input Bias Current	I_{IB}	$V_{IN+} = 0\text{ V}$ $(V_{IN+}) = (V_{IN-}) = 12\text{ V}$			-	1	-	μA
					-	100	-	
Input Offset Current	I_{IO}	$V_{IN+} = 12\text{ V}$, $V_{SENSE} = 10\text{ mV}$ for G20, G50 and G100 $V_{SENSE} = 5\text{ mV}$ for G200			-	± 15	-	μA

NCS21673, NCV21673, NCS21674, NCV21674

ELECTRICAL CHARACTERISTICS (continued)

At $T_A = +25^\circ\text{C}$, $V_{\text{SENSE}} = (V_{\text{IN}+}) - (V_{\text{IN}-})$; $V_S = 5\text{ V}$, $V_{\text{IN}+} = 12\text{ V}$, unless otherwise noted. **Boldface** limits apply over the specified temperature range, $T_A = -40^\circ\text{C}$ to 125°C unless otherwise noted, guaranteed by characterization and/or design.

Parameter	Symbol	Conditions	Min	Typ	Max	Unit
-----------	--------	------------	-----	-----	-----	------

OUTPUT

Gain	G	G 20	-	20	-	V/V
		G 50	-	50	-	
		G 100	-	100	-	
		G 200	-	200	-	
Gain Error		$T_A = 25^\circ\text{C}$	-	± 0.1	-	%
		$T_A = -40^\circ\text{C}$ to $+125^\circ\text{C}$	-	-	± 0.4	
Gain Error vs Temperature		$T_A = -40^\circ\text{C}$ to $+125^\circ\text{C}$	-	± 1.5	± 20	ppm/ $^\circ\text{C}$
Nonlinearity Error			-	± 0.01	-	%
Maximum Capacitive Load	C_L	No sustained oscillation	-	1	-	nF
Settling Time to 1%			-	5	-	μs

VOLTAGE OUTPUT

Output Voltage High, Swing from V_S Supply Rail	$V_S - V_{\text{OH}}$	$V_S = 5.5\text{ V}$ $R_L = 10\text{ k}\Omega$ to GND, $T_A = 25^\circ\text{C}$	-	0.02	-	V
		$V_S = 5.5\text{ V}$ $R_L = 10\text{ k}$ to GND, $T_A = -40^\circ\text{C}$ to 125°C	-	-	0.03	
Output Voltage Low, Swing from GND	$V_{\text{OL}} - \text{GND}$	$V_S = 5.5\text{ V}$ $R_L = 10\text{ k}$ to GND, $T_A = 25^\circ\text{C}$	-	0.0005	-	V
		$V_S = 5.5\text{ V}$ $R_L = 10\text{ k}$ to GND, $T_A = -40^\circ\text{C}$ to 125°C	-	-	0.005	

FREQUENCY RESPONSE

Bandwidth ($f_{-3\text{dB}}$)	BW	$C_L = 25\text{ pF}$	G = 20	-	409	-	kHz
			G = 50	-	270	-	
			G = 100	-	240	-	
			G = 200	-	150	-	
Slew Rate (Note 7)	SR		-	2	-	V/ μs	

NOISE

Voltage Noise Density (RTI)*	e_n	F = 1 kHz, G100	-	25	-	nV/ $\sqrt{\text{Hz}}$
------------------------------	-------	-----------------	---	----	---	------------------------

POWER SUPPLY

Quiescent Current per Channel	I_Q	$T_A = 25^\circ\text{C}$	-	195	260	μA
		$T_A = -40^\circ\text{C}$ to $+125^\circ\text{C}$	-	-	300	

Product parametric performance is indicated in the Electrical Characteristics for the listed test conditions, unless otherwise noted. Product performance may not be indicated by the Electrical Characteristics if operated under different conditions.

*RTI = Referred to input.

7. Guaranteed by characterization and/or design.

NCS21673, NCV21673, NCS21674, NCV21674

TYPICAL CHARACTERISTICS (At $T_A = +25^\circ\text{C}$, $V_{\text{SENSE}} = (V_{\text{IN}+}) - (V_{\text{IN}-})$, $V_S = 5.0\text{ V}$, $V_{\text{IN}+} = 12\text{ V}$, and all gains unless otherwise noted.)

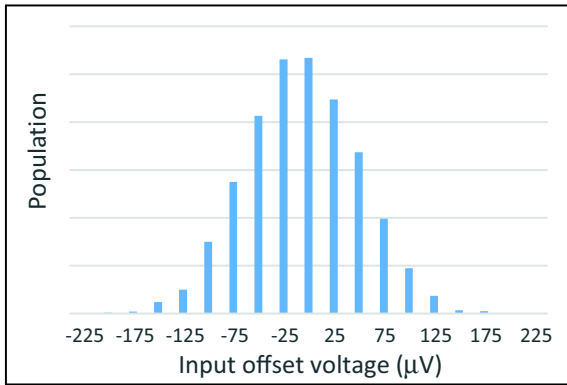

Figure 3a. Input Offset Voltage Distribution, G20

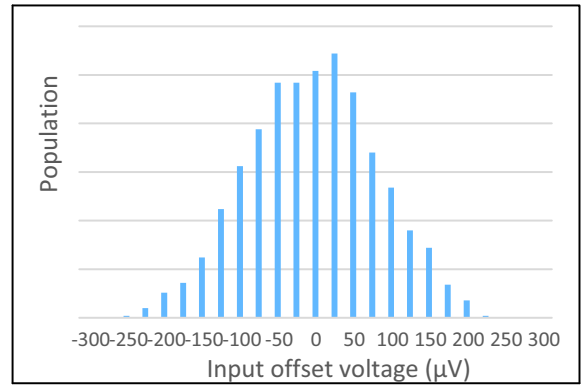

Figure 3b. Input Offset Voltage Distribution, G50

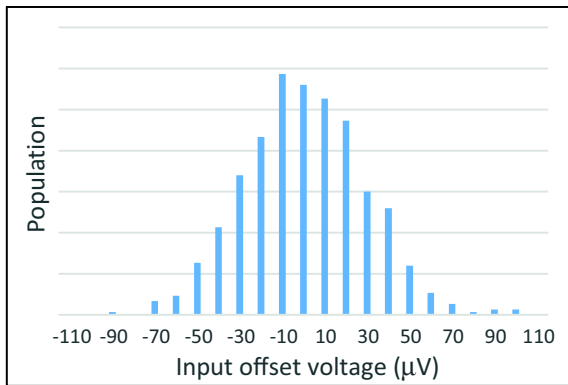

Figure 3c. Input Offset Voltage Distribution, G100

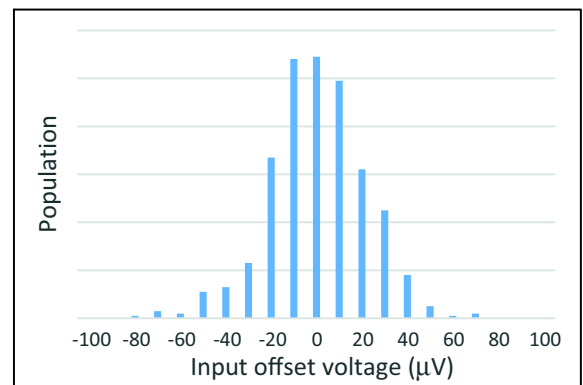

Figure 3d. Input Offset Voltage Distribution, G200

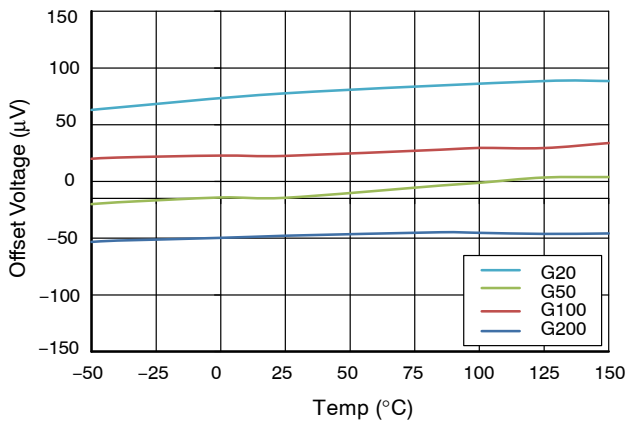

Figure 4. Input Offset vs. Temperature

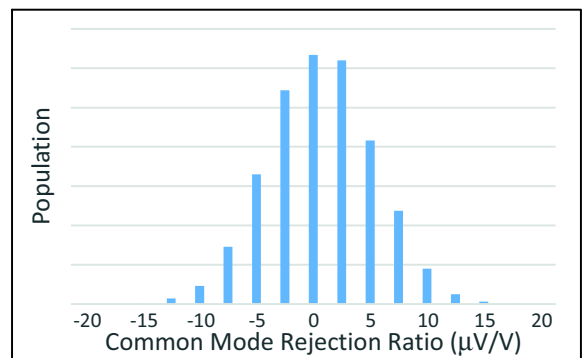

Figure 5a. Common Mode Rejection Ratio Distribution, G20

TYPICAL CHARACTERISTICS (At $T_A = +25^\circ\text{C}$, $V_{\text{SENSE}} = (V_{\text{IN}+}) - (V_{\text{IN}-})$, $V_S = 5.0\text{ V}$, $V_{\text{IN}+} = 12\text{ V}$, and all gains unless otherwise noted.) (continued)

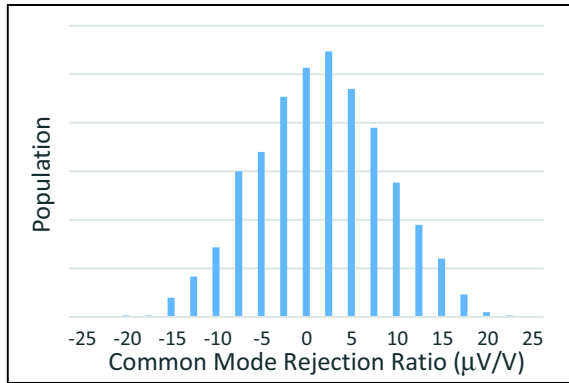

Figure 5b. Common Mode Rejection Ratio Distribution, G50

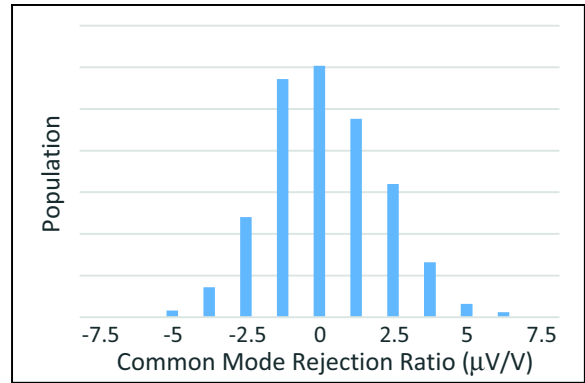

Figure 5c. Common Mode Rejection Ratio Distribution, G100

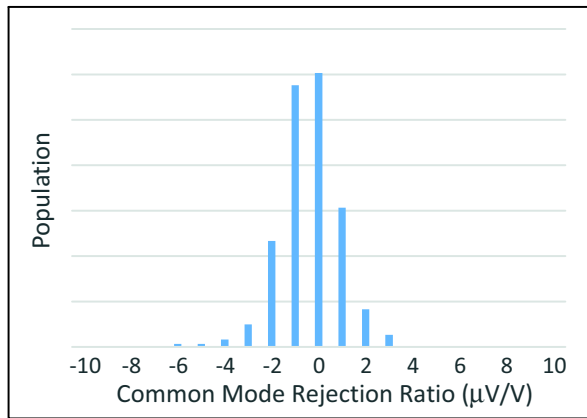

Figure 5d. Common Mode Rejection Ratio Distribution, G200

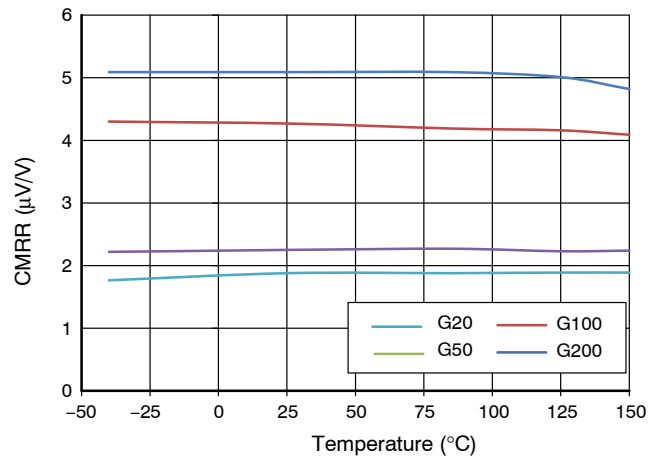

Figure 6. Common Mode Rejection Ratio vs Temperature

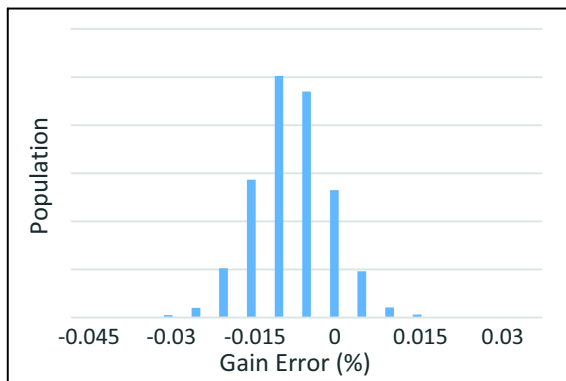

Figure 7a. Gain Error Distribution, G20

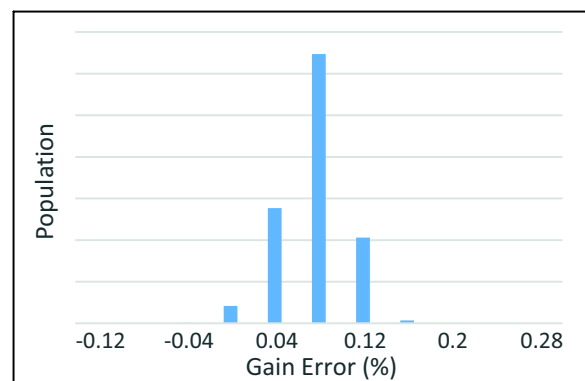

Figure 7b. Gain Error Distribution, G50

NCS21673, NCV21673, NCS21674, NCV21674

TYPICAL CHARACTERISTICS (At $T_A = +25^\circ\text{C}$, $V_{\text{SENSE}} = (V_{\text{IN}+}) - (V_{\text{IN}-})$, $V_S = 5.0\text{ V}$, $V_{\text{IN}+} = 12\text{ V}$, and all gains unless otherwise noted.) (continued)

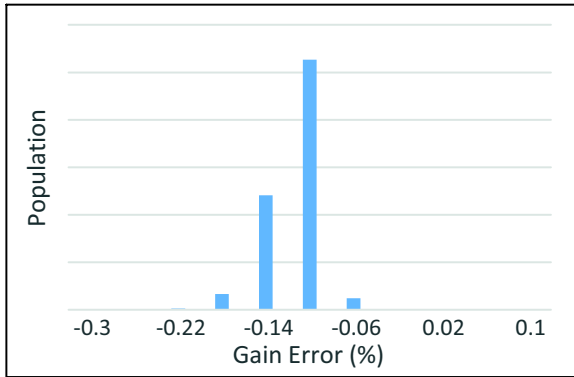

Figure 7c. Gain Error Distribution, G100

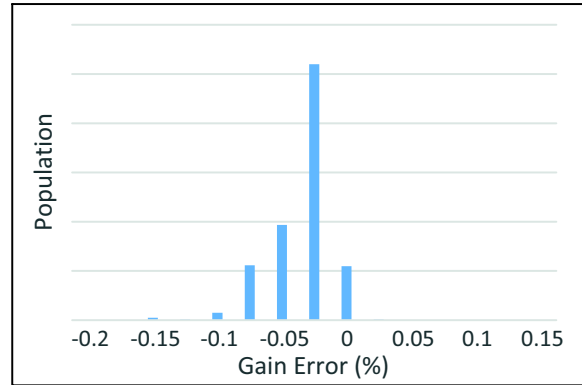

Figure 7d. Gain Error Distribution, G200

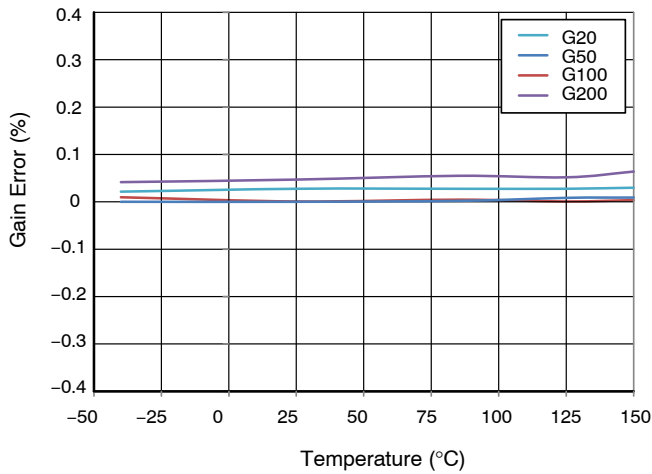

Figure 8. Gain Error vs Temperature

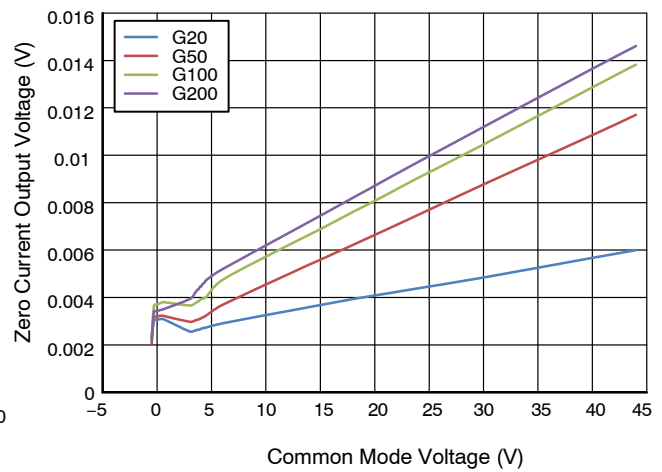

Figure 9. Zero Current Output vs Common Mode Voltage

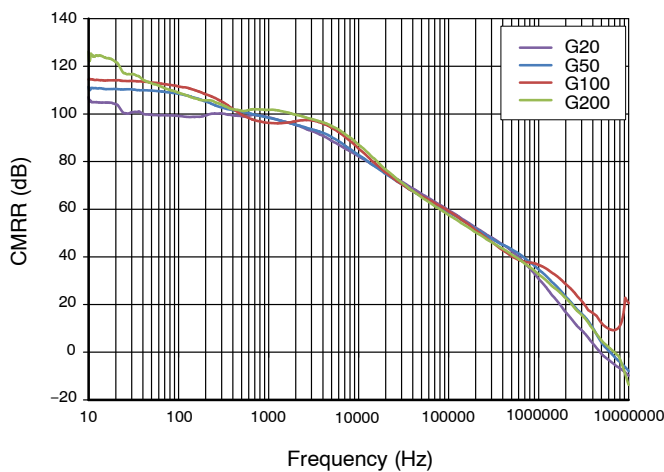

Figure 10. Common Mode Rejection Ratio vs Frequency

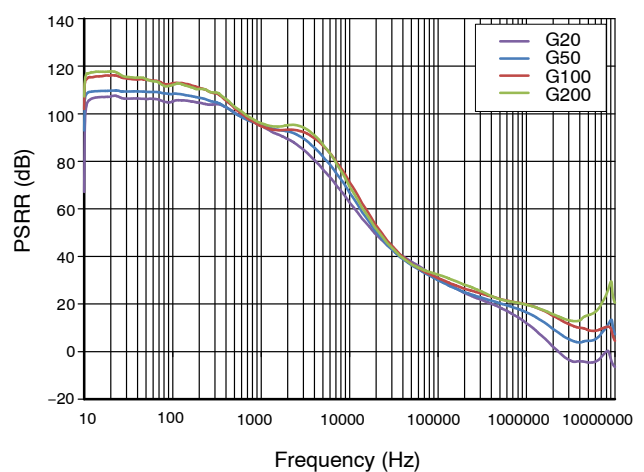

Figure 11. Power Supply Rejection Ratio vs Frequency

NCS21673, NCV21673, NCS21674, NCV21674

TYPICAL CHARACTERISTICS (At $T_A = +25^\circ\text{C}$, $V_{\text{SENSE}} = (V_{\text{IN}+}) - (V_{\text{IN}-})$, $V_S = 5.0\text{ V}$, $V_{\text{IN}+} = 12\text{ V}$, and all gains unless otherwise noted.) (continued)

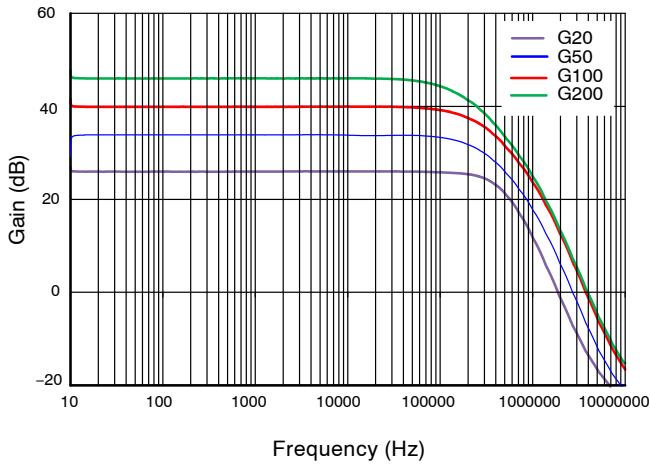

Figure 12. Gain vs Frequency

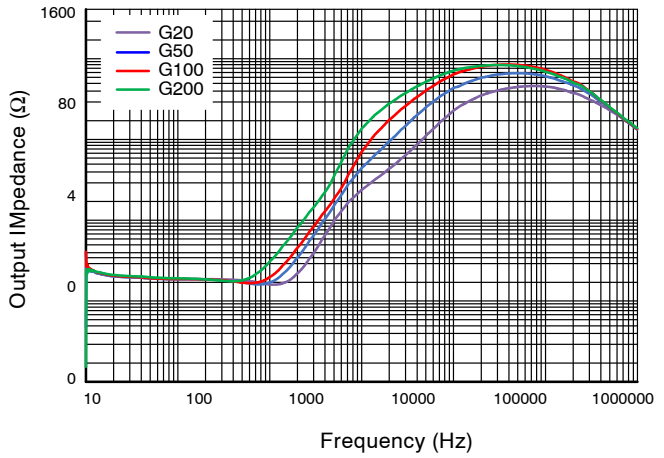

Figure 13. Output Impedance vs Frequency

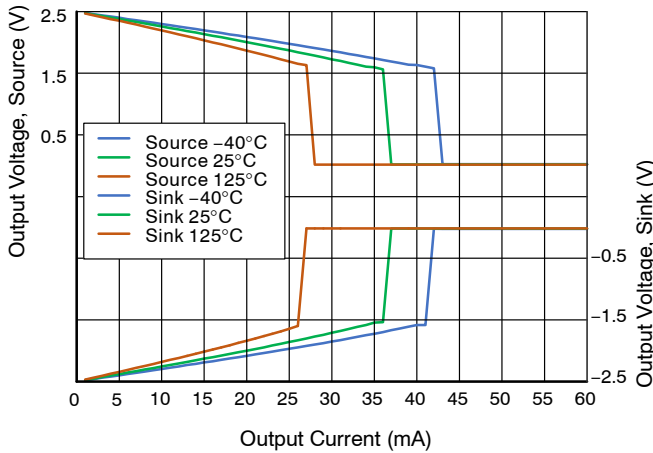

Figure 14. Output Voltage Swing vs Current

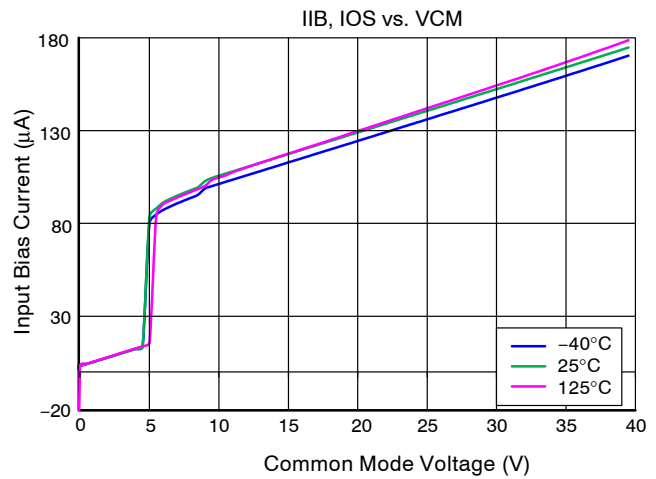

Figure 15. Input Bias Current vs Common Mode Voltage

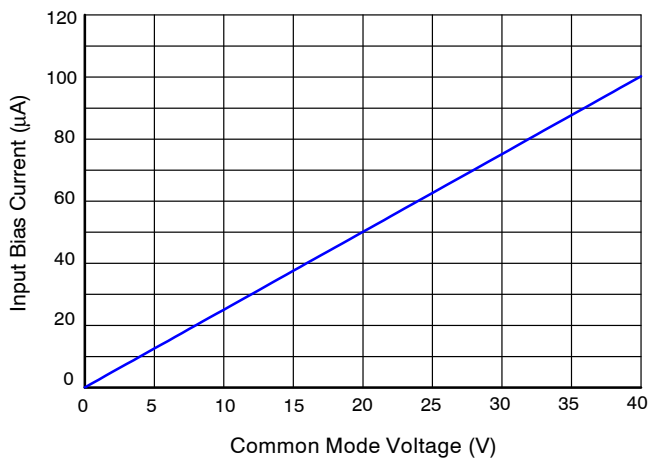

Figure 16. Input Bias Current vs Common Mode Voltage (VS open circuit)

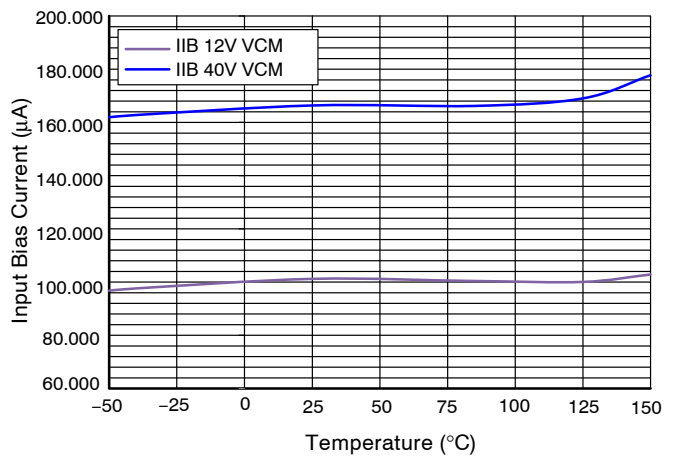

Figure 17. Input Bias Current vs Temperature

NCS21673, NCV21673, NCS21674, NCV21674

TYPICAL CHARACTERISTICS (At $T_A = +25^\circ\text{C}$, $V_{\text{SENSE}} = (V_{\text{IN}+}) - (V_{\text{IN}-})$, $V_S = 5.0\text{ V}$, $V_{\text{IN}+} = 12\text{ V}$, and all gains unless otherwise noted.) (continued)

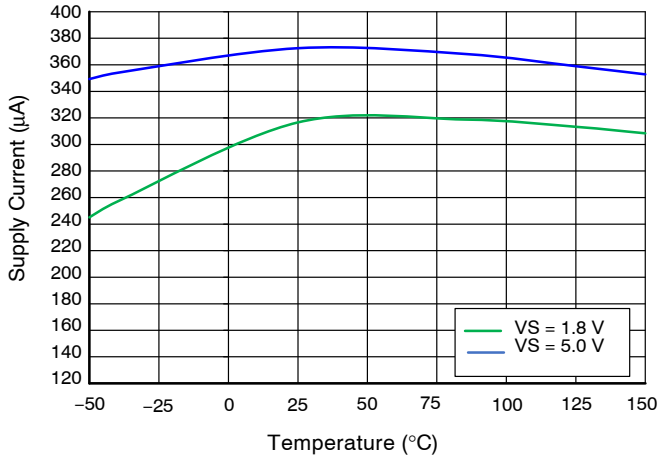

Figure 18. Quiescent Current vs Temperature

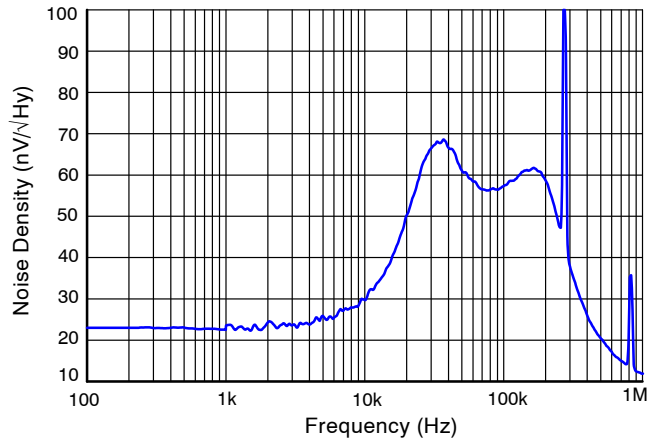

Figure 19. Noise Density, G100

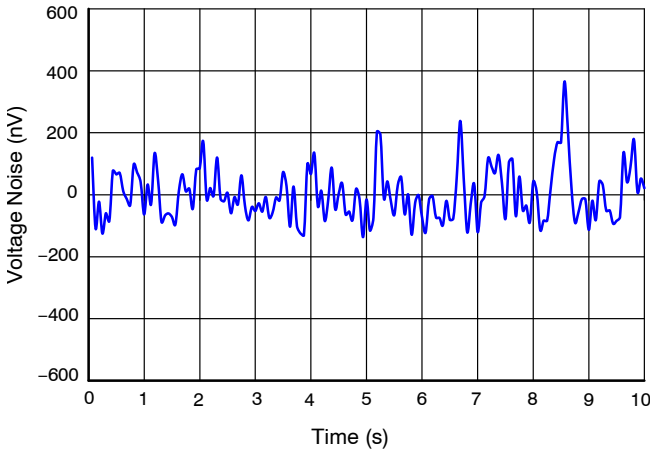

Figure 20. 0.1-Hz to 10-Hz Voltage Noise (Referred-To-Input)

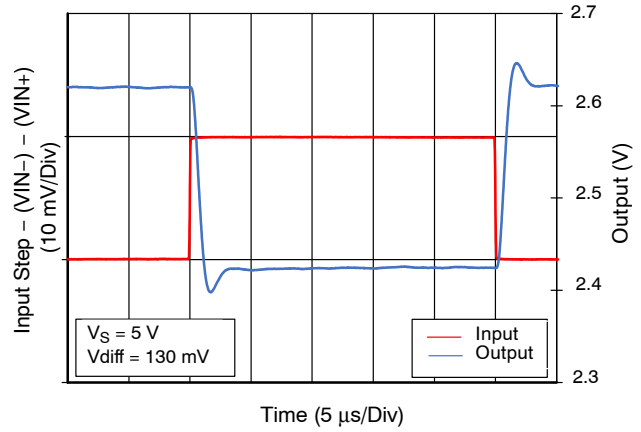

Figure 21a. Small Signal Step Response Inverting, G20

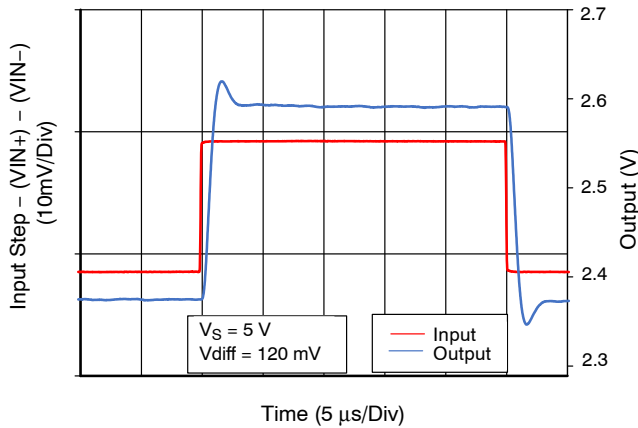

Figure 21b. Small Signal Step Response Non-Inverting, G20

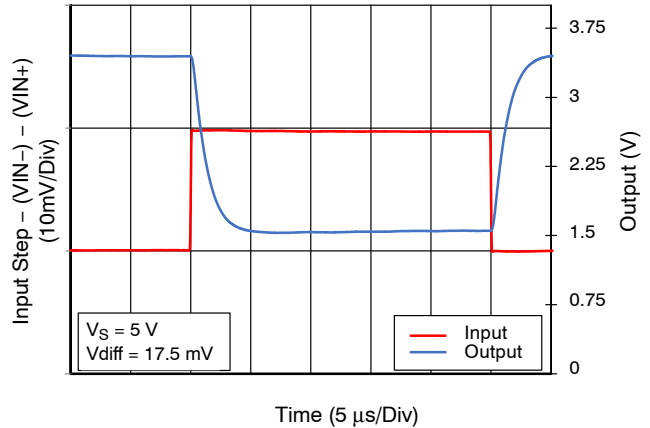

Figure 21c. Small Signal Step Response Inverting, G200

TYPICAL CHARACTERISTICS (At $T_A = +25^\circ\text{C}$, $V_{\text{SENSE}} = (V_{\text{IN}+}) - (V_{\text{IN}-})$, $V_S = 5.0\text{ V}$, $V_{\text{IN}+} = 12\text{ V}$, and all gains unless otherwise noted.) (continued)

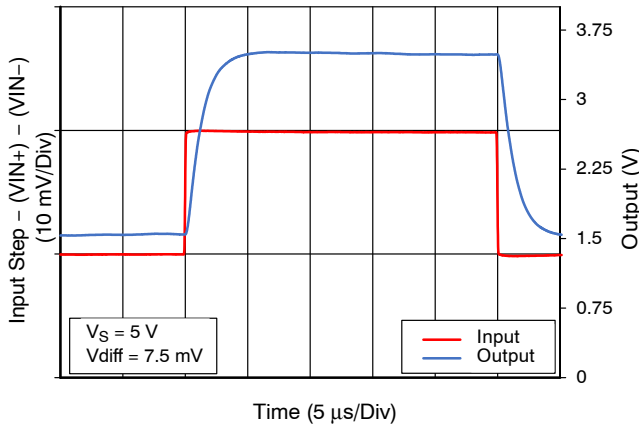

Figure 21d. Small Signal Step Response Non-Inverting, G20

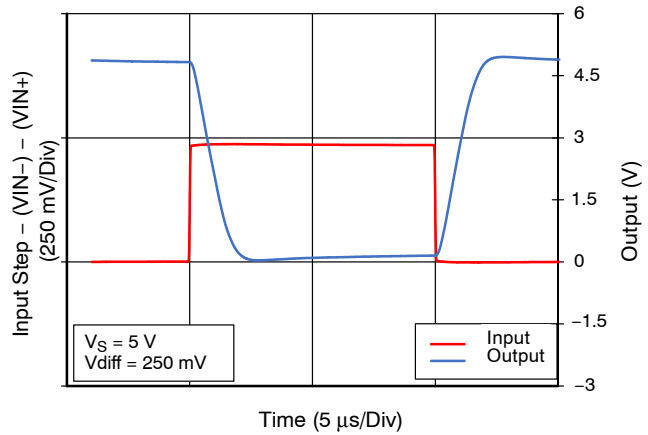

Figure 22a. Large Signal Step Response Inverting, G20

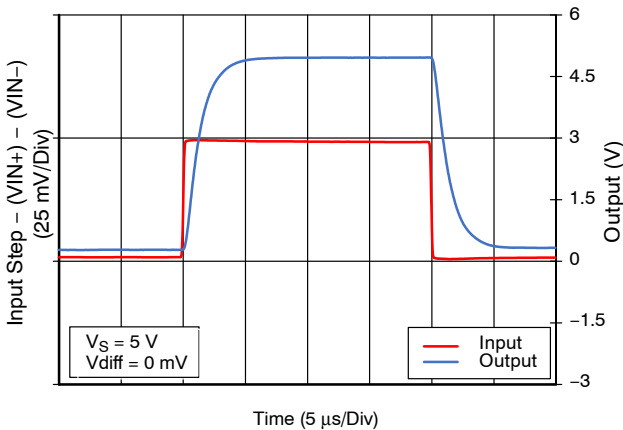

Figure 22b. Large Signal Step Response Non-Inverting, G20

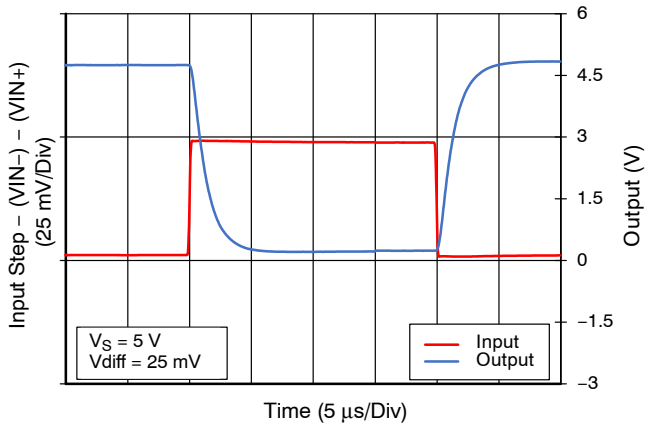

Figure 22c. Small Signal Step Response Inverting, G200

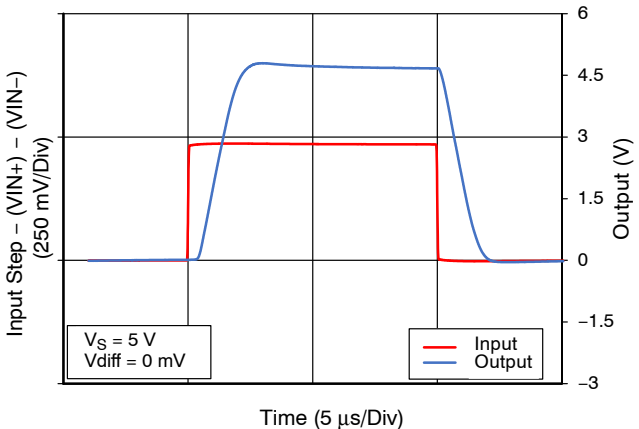

Figure 22d. Large Signal Step Response Non-Inverting, G200

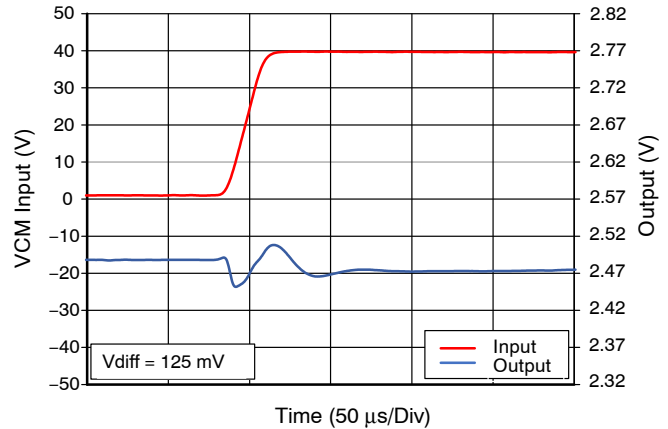

Figure 23a. Common Mode Step Response Rising, G20

NCS21673, NCV21673, NCS21674, NCV21674

TYPICAL CHARACTERISTICS (At $T_A = +25^\circ\text{C}$, $V_{\text{SENSE}} = (V_{\text{IN}+}) - (V_{\text{IN}-})$, $V_S = 5.0\text{ V}$, $V_{\text{IN}+} = 12\text{ V}$, and all gains unless otherwise noted.) (continued)

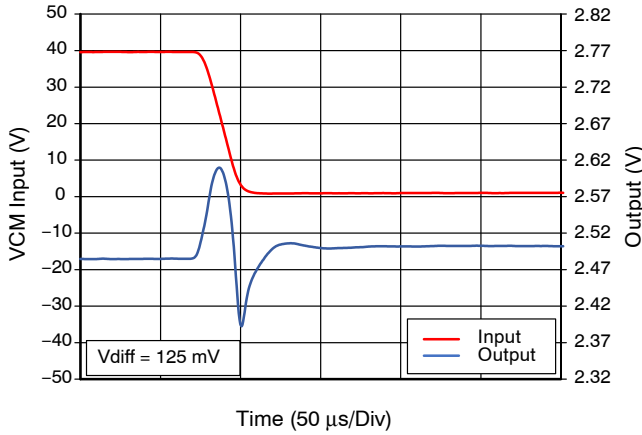

Figure 23b. Common Mode Step Response Falling, G20

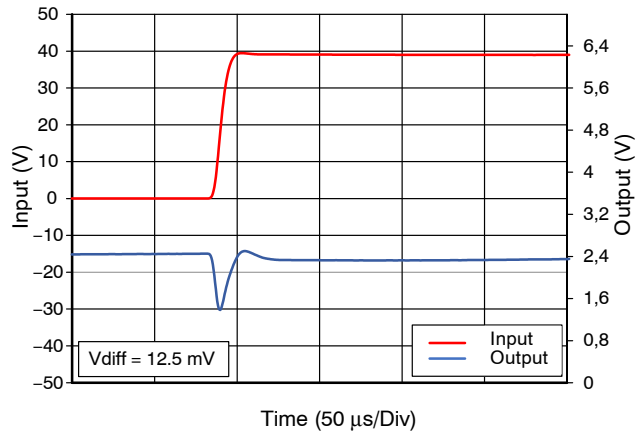

Figure 23c. Common Mode Step Response Rising, G200

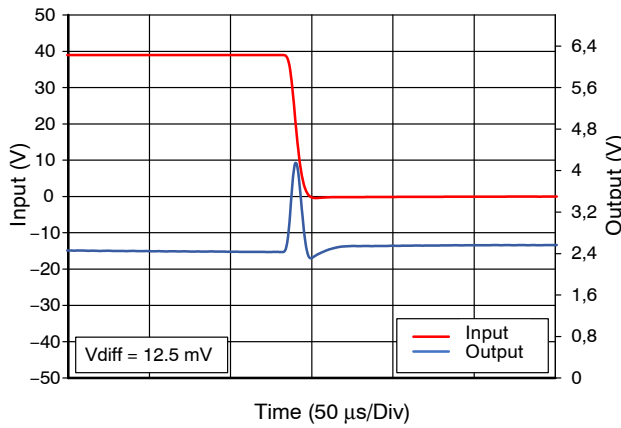

Figure 23d. Common Mode Step Response Rising, G200

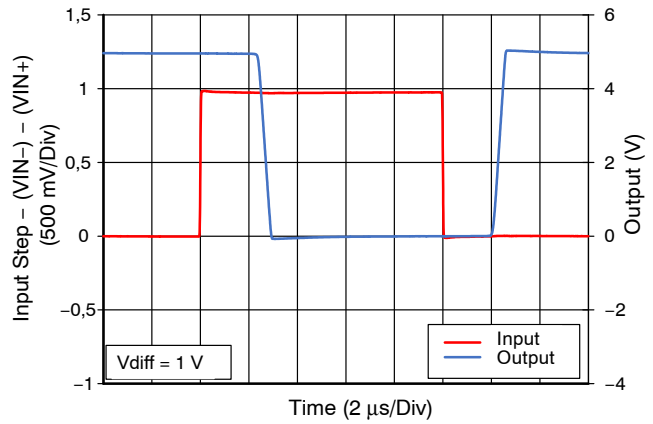

Figure 24a. Overload Response Inverting, G100

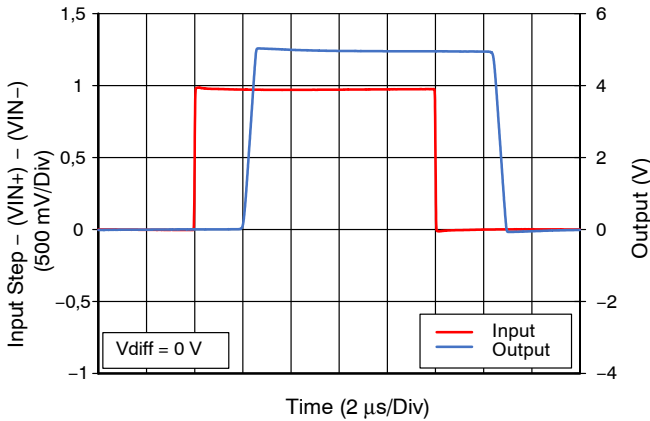

Figure 24b. Overload Response Non-Inverting, G100

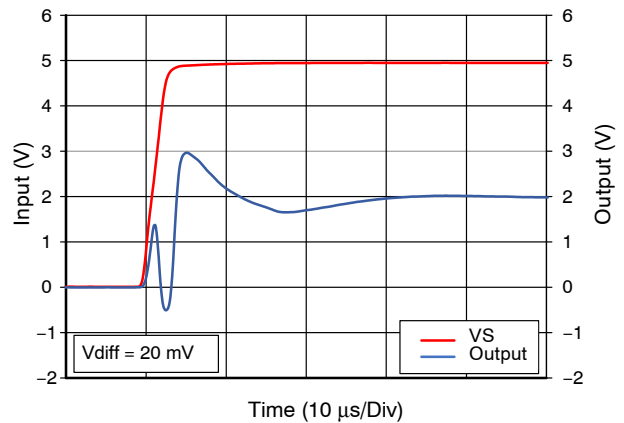

Figure 25a. Startup Response, G100

NCS21673, NCV21673, NCS21674, NCV21674

TYPICAL CHARACTERISTICS (At $T_A = +25^\circ\text{C}$, $V_{\text{SENSE}} = (V_{\text{IN}+}) - (V_{\text{IN}-})$, $V_S = 5.0\text{ V}$, $V_{\text{IN}+} = 12\text{ V}$, and all gains unless otherwise noted.) (continued)

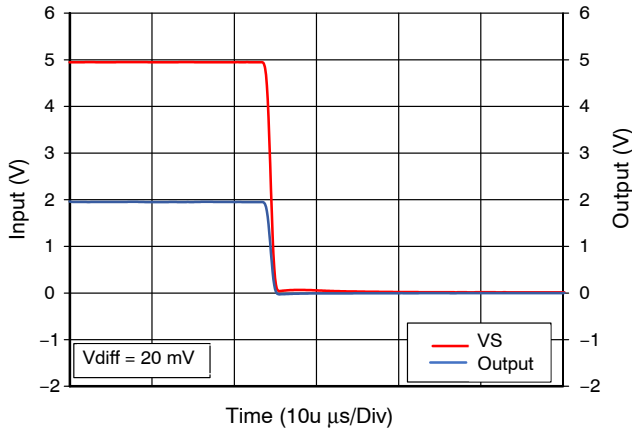

Figure 25b. Shutdown Response, G100

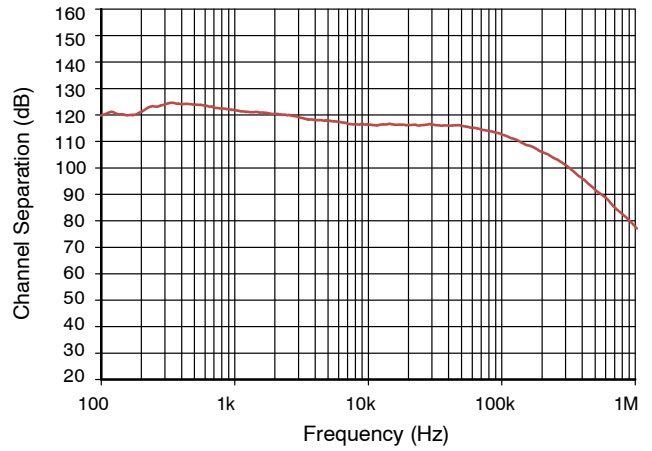

Figure 26. Channel Separation, G200

APPLICATION INFORMATION

Current Sensing Techniques

NCS(V)21673 and NCS(V)21674 are current sense amplifiers featuring a wide common mode voltage range that spans from -0.1 V to -40 V independent of the supply voltage. These amplifiers can be configured for low-side and high-side current sensing.

Unidirectional Operation

In unidirectional current sensing, the measured load current always flows in the same direction. Common applications for unidirectional operation include power supplies and load current monitoring. In this configuration, the IN+ pin should be connected to the high side of the sense resistor, while the IN- pin should be connected to the low side of the sense resistor.

Input Filtering

As shunt resistors decrease in value, shunt inductance can significantly affect frequency response. At values below 1 m, the shunt inductance causes a zero in the transfer function that often results in corner frequencies in the low 100's of kHz. This inductance increases the amplitude of high frequency spike transient events on the current sensing line that can overload the front end of any shunt current sensing IC. This problem must be solved by external filtering at the input of the amplifier. Note that all current sensing IC's are vulnerable to this problem, regardless of manufacturer claims. Filtering is required at the input of the device to resolve this problem, even if the spike frequencies are above the rated -3 dB bandwidth of the device.

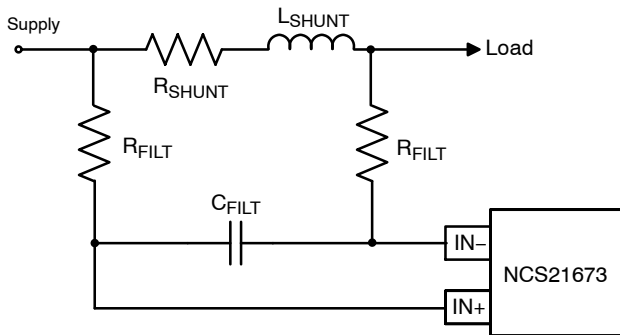

Figure 27.

Ideally, select the capacitor to exactly match the time constant of the shunt resistor and its inductance; alternatively, select the capacitor to provide a pole below that point. Make the input filter time constant equal to or larger than the shunt and its inductance time constant:

$$Freq_{Zero} = 2\pi R_{Shunt} L_{Shunt} \tag{eq. 1}$$

$$Freq_{Pole} = \frac{1}{2\pi(2R_{Filt})C_{Filt}} \tag{eq. 2}$$

While this time constant can be the product of any R_FILT and C_FILT values, the designer needs to take into account that

the R_FILT resistors are connected in series with the internal feedback resistors R3 and R4, hence changing the amplifier's overall gain. Also, the Opamp's input (IIB) currents create a voltage drop across the filtering resistors, which is added to the differential voltage presented to the Opamp's inputs. This voltage is gained by the amplifier adding to the overall error. A good practice is to keep the filtering resistors in the range of a few ohms then size the filtering capacitor accordingly.

The zero-drift architecture contains a 250 KHz sampling circuit that can induce aliasing effects on the current signal. It is recommended to add filtering to the input stage that limits the signal bandwidth to <100 KHz for current signals with high ac spectral content.

Selecting the Shunt Resistor

The desired accuracy of the current measurement determines the precision, shunt size, and the resistor value. The larger the resistor value, the more accurate the measurement possible, but a large resistor value also results in greater current loss.

For the most accurate measurements, use four-terminal current sense resistors. They provide two terminals for the current path in the application circuit, and a second pair for the voltage detection path of the sense amplifier. This technique is also known as *Kelvin Sensing*. This ensures that the voltage measured by the sense amplifier is the actual voltage across the resistor and does not include the small resistance of a combined connection. When using non-Kelvin shunts, follow manufacturer recommendations on how to lay out the sensing traces closely.

Gain Options

The gain is set by integrated, precision, ratio-matched resistors. These current sense amplifiers are available in gain options of 20 V/V, 50 V/V, 100 V/V, and 200 V/V. Adding external resistors to adjust the gain can contribute to the overall system error and is not recommended for multiple reasons. First, the series resistor's mismatch increases the overall gain error and temperature coefficient and lowers the CMRR. Second, the IIB flowing through the external resistors change the differential voltage seen by the opamp's input. Finally, while the internal resistors are well matched in terms of ratio, they have a high tolerance in their absolute value so the resulting gain value may not match the expectations.

Shutdown

While the NCS21673/4 series do not include a shutdown feature, a simple MOSFET, power switch, or logic gate can be used to switch off power and eliminate quiescent current. Note that the input pins connected to the shunt resistor will always have a current flow via the input and feedback resistors (total resistance of each leg is always ~ 400 kΩ). If unpowered, common mode voltage will feedthrough the

NCS21673, NCV21673, NCS21674, NCV21674

VIN– terminal to the output which forms a divider with the 400 kΩ. Vout under unpowered conditions will be:

$$V_{out} = \frac{VIN \cdot (R_{load})}{400K + (R_{load})} \quad (\text{eq. 3})$$

Load resistance to ground should be added to keep Vout within required system limits under this condition.

Also note that when powered, the shunt input pins will exhibit the specified and well-matched bias current. The shunt input pins support the rated common mode voltage when the power is not applied

ORDERING INFORMATION

Device	Channels	Package	Gain	OPN	Marking	Shipping [†]
--------	----------	---------	------	-----	---------	-----------------------

INDUSTRIAL AND CONSUMER

NCS21673	Single	TSOP-5	20	NCS21673SN2G020T1G	AE2	Tape and Reel 3000 / Reel
			50	NCS21673SN2G050T1G**	AE3	
			100	NCS21673SN2G100T1G**	AE4	
			200	NCS21673SN2G200T1G**	AE5	
NCS21674	Dual	Micro8	20	NCS21674DMG020R2G**	G020	Tape and Reel 4000 / Reel
			50	NCS21674DMG050R2G	G050	
			100	NCS21674DMG100R2G	G100	
			200	NCS21674DMG200R2G	G200	

AUTOMOTIVE QUALIFIED

NCV21673*	Single	TSOP-5	20	NCV21673SN2G020T1G	AE2	Tape and Reel 3000 / Reel
			50	NCV21673SN2G050T1G**	AE3	
			100	NCV21673SN2G100T1G**	AE4	
			200	NCV21673SN2G200T1G**	AE5	
NCV21674*	Dual	Micro8	20	NCV21674DMG020R2G**	G020	Tape and Reel 4000 / Reel
			50	NCV21674DMG050R2G	G050	
			100	NCV21674DMG100R2G	G100	
			200	NCV21674DMG200R2G	G200	

[†]For information on tape and reel specifications, including part orientation and tape sizes, please refer to our Tape and Reel Packaging Specifications Brochure, BRD8011/D.

*NCV Prefix for Automotive and Other Applications Requiring Unique Site and Control Change Requirements; AEC-Q100 Qualified and PPAP Capable

**In Development / Consult Sales

MECHANICAL CASE OUTLINE PACKAGE DIMENSIONS

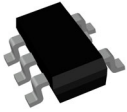

TSOP-5 3.00x1.50x0.95, 0.95P CASE 483 ISSUE P

DATE 01 APR 2024

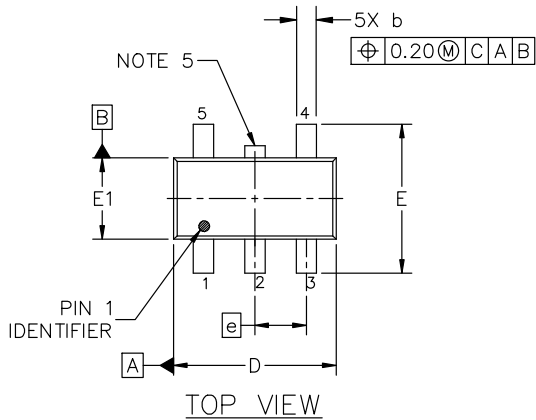

NOTES:

1. DIMENSIONING AND TOLERANCING CONFORM TO ASME Y14.5-2018.
2. ALL DIMENSION ARE IN MILLIMETERS (ANGLES IN DEGREES).
3. MAXIMUM LEAD THICKNESS INCLUDES LEAD FINISH THICKNESS. MINIMUM LEAD THICKNESS IS THE MINIMUM THICKNESS OF BASE MATERIAL.
4. DIMENSIONS D AND E1 DO NOT INCLUDE MOLD FLASH, PROTRUSIONS OF GATE BURRS. MOLD FLASH, PROTRUSIONS, OR GATE BURRS SHALL NOT EXCEED 0.15 PER SIDE. DIMENSION D.
5. OPTIONAL CONSTRUCTION: AN ADDITIONAL TRIMMED LEAD IS ALLOWED IN THIS LOCATION. TRIMMED LEAD NOT TO EXTEND MORE THAN 0.2 FROM BODY.

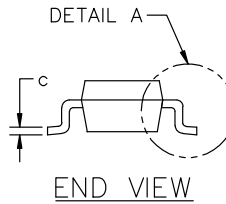
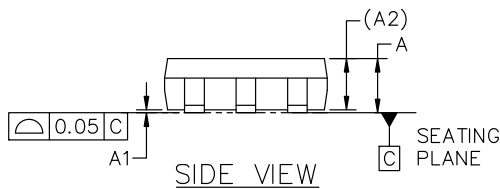

DIM	MILLIMETERS		
	MIN.	NOM.	MAX.
A	0.900	1.000	1.100
A1	0.010	0.055	0.100
A2	0.950 REF.		
b	0.250	0.375	0.500
c	0.100	0.180	0.260
D	2.850	3.000	3.150
E	2.500	2.750	3.000
E1	1.350	1.500	1.650
e	0.950 BSC		
L	0.200	0.400	0.600
θ	0°	5°	10°

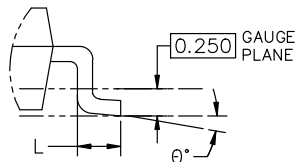

GENERIC MARKING DIAGRAM*

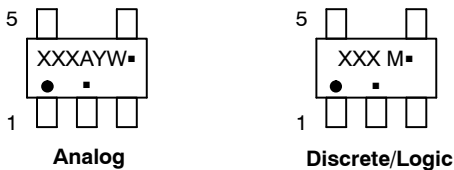

- XXX = Specific Device Code XXX = Specific Device Code
 A = Assembly Location M = Date Code
 Y = Year ▪ = Pb-Free Package
 W = Work Week

▪ = Pb-Free Package
(Note: Microdot may be in either location)

*This information is generic. Please refer to device data sheet for actual part marking. Pb-Free indicator, "G" or microdot "▪", may or may not be present. Some products may not follow the Generic Marking.

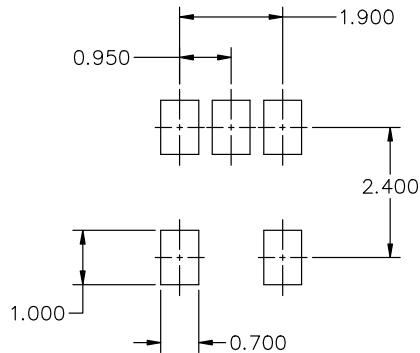

* FOR ADDITIONAL INFORMATION ON OUR Pb-FREE STRATEGY AND SOLDERING DETAILS, PLEASE DOWNLOAD THE ON SEMICONDUCTOR SOLDERING AND MOUNTING TECHNIQUES REFERENCE MANUAL, SOLDERM/D.

DOCUMENT NUMBER:	98ARB18753C	Electronic versions are uncontrolled except when accessed directly from the Document Repository. Printed versions are uncontrolled except when stamped "CONTROLLED COPY" in red.
DESCRIPTION:	TSOP-5 3.00x1.50x0.95, 0.95P	PAGE 1 OF 1

onsemi and ONSEMI are trademarks of Semiconductor Components Industries, LLC dba onsemi or its subsidiaries in the United States and/or other countries. onsemi reserves the right to make changes without further notice to any products herein. onsemi makes no warranty, representation or guarantee regarding the suitability of its products for any particular purpose, nor does onsemi assume any liability arising out of the application or use of any product or circuit, and specifically disclaims any and all liability, including without limitation special, consequential or incidental damages. onsemi does not convey any license under its patent rights nor the rights of others.

MECHANICAL CASE OUTLINE

PACKAGE DIMENSIONS

ON Semiconductor®



SCALE 2:1

Micro8 CASE 846A-02 ISSUE K

DATE 16 JUL 2020



TOP VIEW

NOTE 3



SIDE VIEW



END VIEW

NOTES:

1. DIMENSIONING AND TOLERANCING PER ASME Y14.5M, 2009.
2. CONTROLLING DIMENSION: MILLIMETERS
3. DIMENSION *b* DOES NOT INCLUDE DAMBAR PROTRUSION. ALLOWABLE PROTRUSION SHALL BE 0.10 mm IN EXCESS OF MAXIMUM MATERIAL CONDITION.
4. DIMENSIONS *D* AND *E* DO NOT INCLUDE MOLD FLASH, PROTRUSION OR GATE BURRS. MOLD FLASH, PROTRUSIONS, OR GATE BURRS SHALL NOT EXCEED 0.15 mm PER SIDE. DIMENSION *E* DOES NOT INCLUDE INTERLEAD FLASH OR PROTRUSION. INTERLEAD FLASH OR PROTRUSION SHALL NOT EXCEED 0.25 mm PER SIDE. DIMENSIONS *D* AND *E* ARE DETERMINED AT DATUM *F*.
5. DATUMS *A* AND *B* ARE TO BE DETERMINED AT DATUM *F*.
6. *A1* IS DEFINED AS THE VERTICAL DISTANCE FROM THE SEATING PLANE TO THE LOWEST POINT ON THE PACKAGE BODY.

$\phi 0.08$ (0.003) M C B S A S

DIM	MILLIMETERS		
	MIN.	NOM.	MAX.
A	---	---	1.10
A1	0.05	0.08	0.15
<i>b</i>	0.25	0.33	0.40
<i>c</i>	0.13	0.18	0.23
<i>D</i>	2.90	3.00	3.10
<i>E</i>	2.90	3.00	3.10
<i>e</i>	0.65 BSC		
<i>H_E</i>	4.75	4.90	5.05
<i>L</i>	0.40	0.55	0.70



RECOMMENDED MOUNTING FOOTPRINT

For additional information on our Pb-Free strategy and soldering details, please download the ON Semiconductor Soldering and Mounting Techniques Reference Manual, SOLDERM/D.

GENERIC MARKING DIAGRAM*



- XXXX = Specific Device Code
- A = Assembly Location
- Y = Year
- W = Work Week
- = Pb-Free Package

(Note: Microdot may be in either location)

*This information is generic. Please refer to device data sheet for actual part marking. Pb-Free indicator, "G" or microdot "▪", may or may not be present. Some products may not follow the Generic Marking.

STYLE 1:

1. SOURCE
2. SOURCE
3. SOURCE
4. GATE
5. DRAIN
6. DRAIN
7. DRAIN
8. DRAIN

STYLE 2:

1. SOURCE 1
2. GATE 1
3. SOURCE 2
4. GATE 2
5. DRAIN 2
6. DRAIN 2
7. DRAIN 1
8. DRAIN 1

STYLE 3:

1. N-SOURCE
2. N-GATE
3. P-SOURCE
4. P-GATE
5. P-DRAIN
6. P-DRAIN
7. N-DRAIN
8. N-DRAIN

DOCUMENT NUMBER:	98ASB14087C	Electronic versions are uncontrolled except when accessed directly from the Document Repository. Printed versions are uncontrolled except when stamped "CONTROLLED COPY" in red.
DESCRIPTION:	MICRO8	PAGE 1 OF 1

ON Semiconductor and ON are trademarks of Semiconductor Components Industries, LLC dba ON Semiconductor or its subsidiaries in the United States and/or other countries. ON Semiconductor reserves the right to make changes without further notice to any products herein. ON Semiconductor makes no warranty, representation or guarantee regarding the suitability of its products for any particular purpose, nor does ON Semiconductor assume any liability arising out of the application or use of any product or circuit, and specifically disclaims any and all liability, including without limitation special, consequential or incidental damages. ON Semiconductor does not convey any license under its patent rights nor the rights of others.

onsemi, **Onsemi**, and other names, marks, and brands are registered and/or common law trademarks of Semiconductor Components Industries, LLC dba "**onsemi**" or its affiliates and/or subsidiaries in the United States and/or other countries. **onsemi** owns the rights to a number of patents, trademarks, copyrights, trade secrets, and other intellectual property. A listing of **onsemi**'s product/patent coverage may be accessed at www.onsemi.com/site/pdf/Patent-Marking.pdf. **onsemi** reserves the right to make changes at any time to any products or information herein, without notice. The information herein is provided "as-is" and **onsemi** makes no warranty, representation or guarantee regarding the accuracy of the information, product features, availability, functionality, or suitability of its products for any particular purpose, nor does **onsemi** assume any liability arising out of the application or use of any product or circuit, and specifically disclaims any and all liability, including without limitation special, consequential or incidental damages. Buyer is responsible for its products and applications using **onsemi** products, including compliance with all laws, regulations and safety requirements or standards, regardless of any support or applications information provided by **onsemi**. "Typical" parameters which may be provided in **onsemi** data sheets and/or specifications can and do vary in different applications and actual performance may vary over time. All operating parameters, including "Typicals" must be validated for each customer application by customer's technical experts. **onsemi** does not convey any license under any of its intellectual property rights nor the rights of others. **onsemi** products are not designed, intended, or authorized for use as a critical component in life support systems or any FDA Class 3 medical devices or medical devices with a same or similar classification in a foreign jurisdiction or any devices intended for implantation in the human body. Should Buyer purchase or use **onsemi** products for any such unintended or unauthorized application, Buyer shall indemnify and hold **onsemi** and its officers, employees, subsidiaries, affiliates, and distributors harmless against all claims, costs, damages, and expenses, and reasonable attorney fees arising out of, directly or indirectly, any claim of personal injury or death associated with such unintended or unauthorized use, even if such claim alleges that **onsemi** was negligent regarding the design or manufacture of the part. **onsemi** is an Equal Opportunity/Affirmative Action Employer. This literature is subject to all applicable copyright laws and is not for resale in any manner.

ADDITIONAL INFORMATION

TECHNICAL PUBLICATIONS:

Technical Library: www.onsemi.com/design/resources/technical-documentation
onsemi Website: www.onsemi.com

ONLINE SUPPORT: www.onsemi.com/support

For additional information, please contact your local Sales Representative at www.onsemi.com/support/sales